



SPEAR & JACKSON

PRODUCT GUIDE 2015



GARDEN TOOLS

HAND TOOLS

AIR TOOLS

ECLIPSE TOOLS

ECLIPSE MAGNETICS

CONTACT US:

Ph: 1300 731 818

Fax: 1300 735 858

Email: sales@spear-and-jackson.com.au

Web: www.spearandjackson.com.au



SPEAR & JACKSON

Contents



GARDEN TOOLS

GARDEN DIGGING	3
County Timber	4 - 8
County Fibreglass	9
Trade Timber	10
Trade Fibreglass	11
Solid Core	12
Contractor	13
Lawn Care	14 - 16
Select	17 - 20
Traditional	21 - 23
Neverbend	24 - 25
E-Series	26 - 27
Garden Digging Overview	28
GARDEN CUTTING	29
Secateurs	30 - 32
Loppers	32 - 33
Shears	34 - 36
Scythettes	37
Bowsaws & Pruning Saws	38 - 39
Axes & Blocksplitters	40 - 41
Handles	42
COLOURS COLLECTION	43-46

HAND TOOLS

Hand Saws	48 - 50
Hammers	51 - 54
HUCKSON	55
General Hand Tools	56 - 58
Measuring & Marking	59 - 60
Workwear	61 - 63
STAEDTLER	64
FOOTPRINT	65 - 68
MASONRY	69
Brickworking Tools	70 - 75
Plastering Tools	76 - 82
Cement Tools	83 - 87
Tiling Tools	88 - 91
RAGNI	92 - 94
TRULINE	95 - 100

AIR TOOLS

Blow Guns / Tyre Inflators & Oils	103
Staplers, Bradders & Nailers	104 - 105
Kits & Accessories	106
Spray Guns	107
Air Hose & Fittings	108 - 109
Staples, Brads & Nails	110

ECLIPSE PROFESSIONAL TOOLS

Metal Cutting	115 - 120
Chisels	121
Locking Jaw Pliers	122 - 125
Workholding Solutions	126 - 133
Magnetic Lifters	134 - 136
Gripping & Plumbing	137 - 141
Riveters & Threaded Insert Setting Tools	140 - 142
Engineers' Tools	143 - 145
Magnetic Solutions	146 - 148

INDEX

150 - 151



**SPEAR &
JACKSON**

GARDEN TOOLS

2015

DIGGING TOOLS

LAWN CARE

CUTTING TOOLS

© SPEAR & JACKSON

COUNTY TIMBER RANGE

garden digging



The Spear & Jackson County Digging Range consists of a comprehensive range of shovels, forks, scoops, rakes & mattocks. The combination of the heavy duty carbon steel heads and hard wearing timber handles make them the ideal choice for gardeners and DIY users. This range offers great value for money without compromising on quality, durability or appearance.

Shovels - Long Handle



Post Hole Shovel Long Timber Handle



Part No	Type	Head Size	Pack Qty
SJ-CGPH1	Post Hole	275mm x 200mm	6

- Ideal For Digging Post Holes, Clearing & Mixing Work
- 2mm Carbon Steel Head
- Reinforced Collar
- 1190mm Long Timber Handle
- FSC Certified Handle

Square Mouth Shovel Long Timber Handle



Part No	Type	Head Size	Pack Qty
SJ-CGSH1L	Square Mouth	315mm x 256mm	6

- Ideal For Shoveling Soils, Sand & Garden Materials
- 2mm Carbon Steel Head
- Reinforced Collar
- 1190mm Long Timber Handle
- FSC Certified Handle

Round Mouth Shovel Long Timber Handle



Part No	Type	Head Size	Pack Qty
SJ-CGSP1L	Round Mouth	320mm x 285mm	6

- Ideal For Digging, Shoveling, Spreading & Shifting
- 2mm Carbon Steel Head
- Reinforced Collar
- 1190mm Long Timber Handle
- FSC Certified Handle

Trenching Shovel Long Timber Handle



Part No	Type	Head Size	Pack Qty
SJ-CTS1L	Trenching	300mm x 105mm	6

- Ideal For Digging Trenches, Drains & Narrow Tasks
- 2mm Carbon Steel Head
- Reinforced Collar
- 1190mm Long Timber Handle
- FSC Certified Handle

COUNTY TIMBER RANGE

garden digging

Shovels - D-Handle



Cottage Spade D-Handle



Part No	Type	Head Size	Pack Qty
SJ-CCS1	Cottage Spade	240mm x 155mm	6

- Ideal For Narrow Digging Tasks
- 2mm Carbon Steel Head
- Reinforced Collar
- FSC Certified Timber
- Timber Shaft with Plastic D-Handle

Garden Spade D-Handle



Part No	Type	Head Size	Pack Qty
SJ-CGSP1	Garden Spade	305mm x 190mm	6

- Ideal For Digging In Soils & Clay
- 2mm Carbon Steel Head
- Reinforced Collar
- FSC Certified Timber
- Timber Shaft with Plastic D-Handle

Square Mouth Shovel D-Handle



Part No	Type	Head Size	Pack Qty
SJ-CGSH1	Square Mouth	280mm x 210mm	6

- Ideal For Shoveling Soils, Sand & Garden Materials
- 2mm Carbon Steel Head
- Reinforced Collar
- FSC Certified Timber
- Timber Shaft with Plastic D-Handle

Round Mouth Shovel D-Handle



Part No	Type	Head Size	Pack Qty
SJ-CGSRMD	Round Mouth	320mm x 285mm	6

- Ideal For Digging, Shoveling, Spreading & Shifting
- 2mm Carbon Steel Head
- Reinforced Collar
- FSC Certified Timber
- Timber Shaft with Plastic D-Handle

Garden Fork - D-Handle



Garden Fork D-Handle



Part No	Type	Head Size	Pack Qty
SJ-CGF1	Garden Fork	320mm x 200mm	6

- Ideal For Digging, Cultivating & Turning Over Soil
- 4 Strong Carbon Steel Tines
- FSC Certified Timber
- Timber Shaft with Plastic D-Handle

COUNTY TIMBER RANGE

garden digging



The Spear & Jackson County Range consists of a concise range of Forks, Mattocks and Scoops specifically designed for gardeners and D.I.Y users.

Forks - Hay & Manure

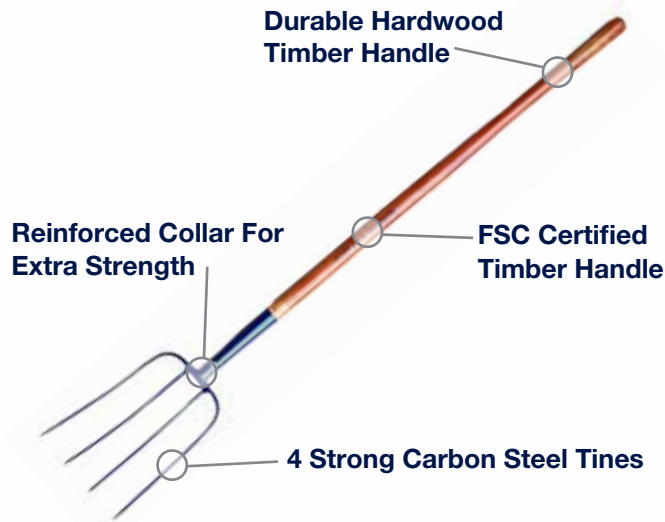

Manure Fork
Long Timber Handle

Hay Fork
Long Timber Handle

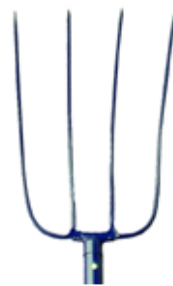

Part No	Type	Head Size	Pack Qty	Part No	Type	Head Size	Pack Qty
SJ-MF1	Manure Fork	360mm x 220mm	6	SJ-HF1	Hay Fork	320mm x 200mm	6

- Ideal For Spreading & Turning Manure
- 4 x Tapered Oval Steel Tines
- Factory Sharpened Tines
- 1200mm Long Timber Handle
- FSC Certified Timber

- Ideal For Shifting Hay
- 3 x Tapered Oval Steel Tines
- Factory Sharpened Tines
- 1200mm Long Timber Handle
- FSC Certified Timber

Mattocks

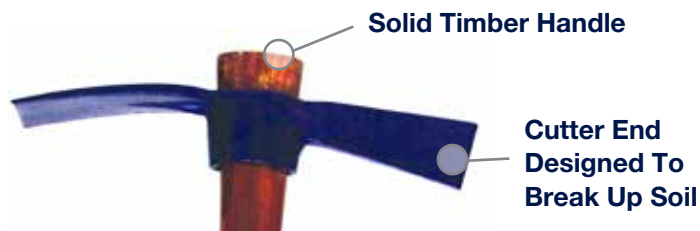

Mattock - Cutter End
Timber Handle

Mattock - Pick End
Timber Handle

Aluminium Scoops



Grain / Mulch Scoop
Long Timber Handle

Grain / Mulch Scoop
D-Handle



Part No	Type	Head Size	Pack Qty
SJ-CMATT/W	Mattock - Cutter	430 x 90mm	3

Part No	Type	Head Size	Pack Qty
SJ-CMATT/PK	Mattock - Pick	490 x 90mm	2

Part No	Type	Head Size	Pack Qty
SJ-ASG55	Soil Scoop	420mm x 290mm	6

Part No	Type	Head Size	Pack Qty
SJ-AS56	Soil Scoop	420mm x 290mm	6

- Ideal For Trenching & Breaking Up Soil
- Heavy Duty Carbon Steel Head
- Solid Timber Handle
- FSC Certified Timber

- Ideal For Trenching & Cutting Through Roots & Debris
- Heavy Duty Carbon Steel Head
- Solid Timber Handle
- FSC Certified Timber

- Ideal For Shifting And Spreading Grain & Mulch
- Large Aluminium Scoop
- 1200mm Long Timber Handle
- FSC Certified Timber

- Ideal For Shifting And Spreading Grain & Mulch
- Large Aluminium Scoop
- Timber Shaft with Plastic D-Handle
- FSC Certified Timber

COUNTY TIMBER RANGE

garden digging & spreading



Rakes & Soil Spreaders



Rake - 14 Tines
Long Timber Handle

Rake - 16 Tines
Long Timber Handle

Landscapers Rake
Long Timber Handle

Soil Spreader
Long Timber Handle



Part No	Type	Head Size	Pack Qty
SJ-CGR1	Rake - 14 Tines	350mm x 75mm	6

- Ideal For Raking And Clearing Soils, Leaves, Stones & Other Garden Fillings
- Powder Coated Carbon Steel Head
- 1200mm Long Timber Handle
- Tapered Socket
- FSC Certified Timber

Part No	Type	Head Size	Pack Qty
SJ-CGR2	Rake - 16 Tines	400mm x 75mm	6

- Ideal For Raking And Clearing Soils, Leaves, Stones & Other Garden Fillings
- Powder Coated Carbon Steel Head
- 1200mm Long Timber Handle
- Tapered Socket
- FSC Certified Timber

Part No	Type	Head Size	Pack Qty
SJ-LR1	Rake - 18 Tines	460mm x 100mm	6

- Ideal For Raking And Clearing Soils, Leaves, Stones & Other Garden Fillings
- Spreading Bar for Added Strength
- Powder Coated Carbon Steel Head with Stays
- 1200mm Long Timber Handle
- Tapered Socket
- FSC Certified Timber

Part No	Type	Head Size	Pack Qty
SJ-SS1	Soil Spreader	700mm x 260mm	6

- 700mm Spreading Width
- Tubular Steel Spreading
- Long Hardwood Timber Handle
- FSC Certified Timber

Hoes & Cultivators



Dutch Hoe - A flat, sharp edged blade, angled to be pushed backwards and forwards for breaking the soil surface and destroying weeds. Designed for chipping, weeding, cultivating & mulching.

Swan Neck Designed for deeper hoeing and cultivating. Ideal for breaking up soil, weeding and cultivating. Works soil and destroys weeds with a chopping action.

Mortar Hoe Designed for breaking up soil, weeding & cultivating. Can also be used for quick mixing of brick, plaster, mortar and small quantities of concrete with outlets in the blade to assist the mixing action.

Cultivator For cultivating and general garden maintenance. Suitable for shallow cultivation and aeration of garden beds and around small seedlings to established plants and shrubs.

Hoe - Dutch
Long Timber Handle

Hoe - Swan Neck
Long Timber Handle

Hoe - Mortar
Long Timber Handle

Cultivator - 3 Prong
Long Timber Handle



Part No	Type	Head Size	Pack Qty
SJ-CGDH2	Dutch Hoe	150mm x 125mm	6

- Ideal For Chipping, Weeding, Cultivating & Mulching
- Powder Coated Carbon Steel Head
- Long Timber Handle
- FSC Certified Timber

Part No	Type	Head Size	Pack Qty
SJ-CGH1	Swan Neck Hoe	150mm x 110mm	6

- Ideal For Deeper Hoeing & Cultivating
- Powder Coated Carbon Steel Head
- Long Timber Shaft
- FSC Certified Timber

Part No	Type	Head Size	Pack Qty
SJ-MH1	Mortar Hoe	230mm x 150mm	6

- Ideal For Breaking Up Soil, Weeding & Cultivating
- Powder Coated Carbon Steel Head
- Long Timber Shaft
- FSC Certified Timber

Part No	Type	Head Size	Pack Qty
SJ-CGC1	3-Prong Cultivator	200mm x 150mm	6

- Ideal For Cultivating & General Garden Maintenance
- Powder Coated Carbon Steel Head
- Timber Shaft
- FSC Certified Timber

COUNTY TIMBER RANGE

garden digging hand tools



Hand Tools

Spear & Jackson offers a small range of hand tools specially designed for planting small plants, weeding, breaking up light soils and cultivating.

Hand Trowel PVC Handle



Part No	Type	Head Size	Pack Qty
SJ-SDT/10	Trowel	160mm x 80mm	6

- Ideal for planting small plants, cuttings and seedlings
- Epoxy Coated Carbon Steel Head
- PVC Handle
- Lightweight Design

Hand Transplanter PVC Handle



Part No	Type	Head Size	Pack Qty
SJ-SDT/20	Transplanter	150mm x 50mm	6

- Ideal for planting small plants, cuttings and seedlings
- Epoxy Coated Carbon Steel Head
- PVC Handle
- Lightweight Design

Hand Weeder PVC Handle



Part No	Type	Head Size	Pack Qty
SJ-SDT/30	Weeder	170mm x 50mm	6

- Ideal for removing weeds & small plants from lawns & garden beds
- Epoxy Coated Carbon Steel Head
- PVC Handle
- Lightweight Design

Hand Cultivator PVC Handle



Part No	Type	Head Size	Pack Qty
SJ-SDT/40	Cultivator	150mm x 70mm	6

- Ideal for breaking up light soils and weeding
- Epoxy Coated Carbon Steel Head
- PVC Handle
- Lightweight Design

Hand Fork - Twist PVC Handle



Part No	Type	Head Size	Pack Qty
SJ-SDT/50	Fork - Twist	150mm x 75mm	6

- Ideal for cultivating light soils
- Epoxy Coated Carbon Steel Head
- PVC Handle
- Lightweight Design

Gutter Scoop Plastic



Part No	Type	Head Size	Pack Qty
SJ-GS1	Gutter Scoop	290mm x 60mm	20

- Ideal for gutter cleaning
- Long handle for extra reach
- Large holding capacity
- Lightweight & simple design

Bulb planter Plastic Handle



Part No	Type	Head Size	Pack Qty
SJ-6941	Bulb Planter	113mm x 73mm	10

- Ideal for planting bulbs & digging small holes in soil
- Carbon Steel Body & Plastic Handle
- Quick Release Handle



COUNTY FIBREGLASS RANGE

garden digging



The Spear & Jackson County Fibreglass Digging Range consists of a concise range of long handled shovels & mattocks. The combination of the heavy duty carbon steel head and high quality fibreglass shaft make this the ideal choice for gardeners and DIY users. Offers great value for money without compromising on quality, durability or appearance.

Shovels - Long Fibreglass Handle

High Quality Fibreglass Shaft with Soft Grip Cap

Post Hole Shovel Long Fibreglass Handle



Part No	Type	Head Size	Pack Qty
SJ-SHO/75FG	Post Hole	275mm x 200mm	6

- Ideal For Digging Post Holes, Clearing & Mixing Work
- One Piece Blade & Socket with Powder Coat Finish
- 2mm Heat Treated, High Grade Carbon Steel
- High Quality Fibreglass Shaft with Soft Grip Cap
- Reinforced Collar

Plumbers Shovel Long Fibreglass Handle



Part No	Type	Head Size	Pack Qty
SJ-SHO/80FG	Plumbers	285mm x 180mm	6

- Ideal for Digging Drains, Holes & General Garden Jobs
- One Piece Blade & Socket with Powder Coat Finish
- 2mm Heat Treated, High Grade Carbon Steel
- High Quality Fibreglass Shaft with Soft Grip Cap
- Reinforced Collar

Round Mouth Shovel Long Fibreglass Handle



Part No	Type	Head Size	Pack Qty
SJ-SHO/15FG	Round Mouth	320mm x 285mm	6

- Ideal For Digging, Shoveling, Spreading & Shifting
- One Piece Blade & Socket with Powder Coat Finish
- 2mm Heat Treated, High Grade Carbon Steel
- High Quality Fibreglass Shaft with Soft Grip Cap
- Reinforced Collar

Reinforced Collar For Extra Strength

2mm Heat Treated, High Grade Carbon Steel

Square Mouth Shovel Long Fibreglass Handle



Part No	Type	Head Size	Pack Qty
SJ-SHO/60FG	Square Mouth	315mm x 256mm	6

- Ideal For Shoveling Soils, Sand & Garden Materials
- One Piece Blade & Socket with Powder Coat Finish
- 2mm Heat Treated, High Grade Carbon Steel
- High Quality Fibreglass Shaft with Soft Grip Cap
- Reinforced Collar

Trenching Shovel Long Fibreglass Handle



Part No	Type	Head Size	Pack Qty
SJ-SHO/90FG	Trenching	300mm x 105mm	6

- Ideal For Digging Trenches, Drains & Narrow Tasks
- One Piece Blade & Socket with Powder Coat Finish
- 2mm Heat Treated, High Grade Carbon Steel
- High Quality Fibreglass Shaft with Soft Grip Cap
- Reinforced Collar

Mattocks - Fibreglass Handles

Mattock - Cutter End Fibreglass Handle - Soft Grip



Part No	Type	Head Size	Pack Qty
SJ-MATTFG	Mattock - Cutter	420 x 290mm	3

- Ideal For Trenching & Breaking Up Soil
- Heavy Duty Carbon Steel Head
- High Quality Fibreglass Shaft
- Soft Grip Comfortable Handle

Mattock - Pick End Fibreglass Handle - Soft Grip



Part No	Type	Head Size	Pack Qty
SJ-MATTPKFG	Mattock - Pick	420 x 290mm	2

- Ideal For Trenching & Cutting Through Roots & Debris
- Heavy Duty Carbon Steel Head
- High Quality Fibreglass Shaft
- Soft Grip Comfortable Handle

TRADE TIMBER RANGE

garden digging



Shovels - Trade Timber Handle

The Combination of the Heavy Duty Carbon Steel Heads and High Quality Oak Timber Handles Make them the Ideal Trades Tool. A Professional Range at Extremely Competitive Pricing.



Post Hole Shovel Trade Timber Handle



Part No	Type	Head Size	Pack Qty
SJ-OPHS	Post Hole	275mm x 200mm	6

- Ideal For Digging Post Holes, Clearing & Mixing Work
- Trade Quality
- Strong Oak Timber Handle
- Reinforced Steel Collar
- 2mm Carbon Steel Blade
- FSC Certified Handle
- Maximum Downforce To Handle 130kg+

Plumbers Shovel Trade Timber Handle



Part No	Type	Head Size	Pack Qty
SJ-OPS	Plumbers	285mm x 180mm	6

- Ideal For Digging Drains, Holes & General Garden Jobs
- Trade Quality
- Strong Oak Timber Handle
- Reinforced Steel Collar
- 2mm Carbon Steel Blade
- FSC Certified Handle
- Maximum Downforce To Handle 130kg+

Round Mouth Shovel Trade Timber Handle



Part No	Type	Head Size	Pack Qty
SJ-ORMS	Round Mouth	320mm x 285mm	6

- Ideal For Digging, Shoveling, Spreading & Shifting
- Trade Quality
- Strong Oak Timber Handle
- Reinforced Steel Collar
- 2mm Carbon Steel Blade
- FSC Certified Handle
- Maximum Downforce To Handle 130kg+

Square Mouth Shovel Trade Timber Handle



Part No	Type	Head Size	Pack Qty
SJ-OSMS	Square Mouth	315mm x 256mm	6

- Ideal For Shoveling Soils, Sand & Garden Materials
- Trade Quality
- Strong Oak Timber Handle
- Reinforced Steel Collar
- 2mm Carbon Steel Blade
- FSC Certified Handle
- Maximum Downforce To Handle 130kg+

Trenching Shovel Trade Timber Handle



Part No	Type	Head Size	Pack Qty
SJ-OTS	Trenching	300mm x 105mm	6

- Ideal For Digging Trenches, Drains & Narrow Tasks
- Trade Quality
- Strong Oak Timber Handle
- Reinforced Steel Collar
- 2mm Carbon Steel Blade
- FSC Certified Handle
- Maximum Downforce To Handle 130kg+

TRADE FIBREGLASS RANGE

garden digging



Shovels - Trade Fibreglass Handle

Heavy Duty Carbon Steel Heads and High Quality Fibreglass Handles Make Them the Ideal Trades Tool. A Professional Range Designed For The True Tradesman



Post Hole Shovel

Trade Fibreglass Handle



Part No	Type	Head Size	Pack Qty
SJ-FGPHS	Post Hole	275mm x 200mm	6

- Ideal For Digging Post Holes, Clearing & Mixing Work
- Trade Quality Fibreglass Handle
- Reinforced Steel Collar
- 2mm Carbon Steel Blade
- Solid Fibreglass Head / Handle Insert
- Maximum Downforce To Handle 140kg

Plumbers Shovel

Trade Fibreglass Handle



Part No	Type	Head Size	Pack Qty
SJ-FGPS	Plumbers	285mm x 180mm	6

- Ideal For Digging Drains, Holes & General Garden Jobs
- Trade Quality Fibreglass Handle
- Reinforced Steel Collar
- 2mm Carbon Steel Blade
- Solid Fibreglass Head / Handle Insert
- Maximum Downforce To Handle 140kg

Round Mouth Shovel

Trade Fibreglass Handle



Part No	Type	Head Size	Pack Qty
SJ-FGRMS	Round Mouth	320mm x 285mm	6

- Ideal For Digging, Shoveling, Spreading & Shifting
- Trade Quality Fibreglass Handle
- Reinforced Steel Collar
- 2mm Carbon Steel Blade
- Solid Fibreglass Head / Handle Insert
- Maximum Downforce To Handle 140kg

Square Mouth Shovel

Trade Fibreglass Handle



Part No	Type	Head Size	Pack Qty
SJ-FGSMS	Square Mouth	315mm x 256mm	6

- Ideal For Shoveling Soils, Sand & Garden Materials
- Trade Quality Fibreglass Handle
- Reinforced Steel Collar
- 2mm Carbon Steel Blade
- Solid Fibreglass Head / Handle Insert
- Maximum Downforce To Handle 140kg

Trenching Shovel

Trade Fibreglass Handle



Part No	Type	Head Size	Pack Qty
SJ-FGTS	Trenching	300mm x 105mm	6

- Ideal For Digging Trenches, Drains & Narrow Tasks
- Trade Quality Fibreglass Handle
- Reinforced Steel Collar
- 2mm Carbon Steel Blade
- Solid Fibreglass Head / Handle Insert
- Maximum Downforce To Handle 140kg

SOLID CORE RANGE garden digging



Shovels - Solid Core Fibreglass Handle

A professional trade range ideal for everyday use.

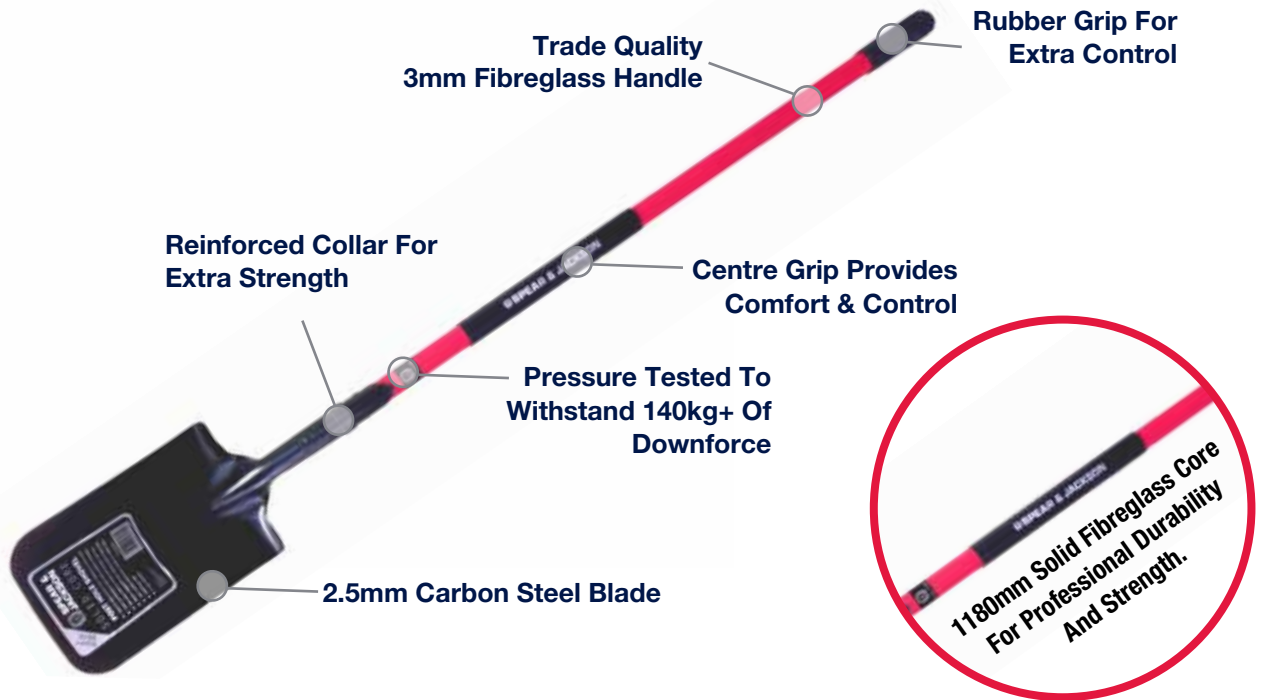

Post Hole Shovel Solid Core - Fibreglass Handle



Part No	Type	Head Size	Pack Qty
SJ-SCPH	Post Hole	275mm x 200mm	6

- Ideal For Digging Post Holes, Clearing & Mixing Work
- Trade Quality Fibreglass Handle
- Heavy Duty 2mm Carbon Steel Head with Reinforced Collar
- 1180mm Solid Fibreglass Head / Handle Insert
- Top and Centre Grip For Extra Comfort & Control
- High Visibility Fluorescent Handle for Added Safety
- Maximum Downforce To Handle 140kg

Plumbers Shovel Solid Core - Fibreglass Handle



Part No	Type	Head Size	Pack Qty
SJ-SCPS	Plumbers	285mm x 180mm	6

- Ideal For Digging Drains, Holes & General Garden Jobs
- Trade Quality Fibreglass Handle
- Heavy Duty 2mm Carbon Steel Head with Reinforced Collar
- 1180mm Solid Fibreglass Head / Handle Insert
- Top and Centre Grip For Extra Comfort & Control
- High Visibility Fluorescent Handle for Added Safety
- Maximum Downforce To Handle 140kg

General Purpose Shovel Solid Core - Fibreglass Handle



Part No	Type	Head Size	Pack Qty
SJ-SCGP	General Purpose	275mm x 200mm	6

- Ideal For Shoveling Soils, Sand & Garden Materials
- Trade Quality Fibreglass Handle
- Heavy Duty 2mm Carbon Steel Head with Reinforced Collar
- 1180mm Solid Fibreglass Head / Handle Insert
- Top and Centre Grip For Extra Comfort & Control
- High Visibility Fluorescent Handle for Added Safety
- Maximum Downforce To Handle 140kg

CONTRACTOR digging

Professional Solid Forged

The Spear & Jackson Contractor Range consists of a concise range of Spades, Forks and Pincers specifically designed for professional and trade use.



Spade Solid Forged Head



**10
YEAR
GUARANTEE**

Part No	Type	Head Size	Pack Qty
SJ-1071AL	Spade	290mm x 190mm	5

- MYD Handle
- Solid Forged Carbon Steel Head & Socket
- Long Lipped Socket, Riveted For Added Strength
- Hammer Finish Epoxy Coated Head For Improved Resistance To Rust, Scratches, Humidity & Alkalis In The Soil
- Weatherproofed Hardwood Shaft For Greater Durability
- Treaded For More Comfortable Digging

Fork Solid Forged Head



**10
YEAR
GUARANTEE**

Part No	Type	Head Size	Pack Qty
SJ-1570AL	Fork	290mm x 190mm	5

- MYD Handle
- Solid Forged Carbon Steel Head & Socket
- Long Lipped Socket, Riveted For Added Strength
- Hammer Finish Epoxy Coated Head For Improved Resistance To Rust, Scratches, Humidity & Alkalis In The Soil
- Weatherproofed Hardwood Shaft For Greater Durability

Draining Spade Solid Forged Head



Part No	Type	Head Size	Pack Qty
SJ-2154HK	Draining Spade	405mm x 165mm	5

- MYD Handle
- Solid Forged Carbon Steel Head & Socket
- Rotary Welded Shaft & Head
- Hammer Finish Epoxy Coated Head For Improved Resistance To Rust, Scratches, Humidity & Alkalis In The Soil

All Steel Shovels



Square Mouth All Steel D-Handle



Part No	Type	Head Size	Pack Qty
SJ-WS350	Square Mouth	300mm x 255mm	6

- Ideal For Shovelling / Mixing Soils, Sand & Concrete
- All Steel Construction
- Extra Long 30" Handle for Extra Reach
- All Metal D-Handle

Square Mouth All Steel Long Handle



Part No	Type	Head Size	Pack Qty
SJ-WS360L	Square Mouth	300mm x 255mm	6

- Ideal For Shovelling / Mixing Soils, Sand & Concrete
- All Steel Construction
- Long Handle with Soft Grip End Cap
- Overall Length 1240mm

Post Hole Pincers

Rubber End Grips For Comfort



Strong Tubular Steel Handles

2.5mm Heat Treated Carbon Steel Head



Post Hole Pincers Tubular Steel Handles



Part No	Type	Head Size	Pack Qty
SJ-PPHM	Post Hole Pincers	250mm x 120mm	4

- Ideal For Digging & Clearing Post Holes
- Reinforced Collar
- 2.5mm Heat Treated Carbon Steel Head
- High Strength Tubular Steel Handles
- Rubber End Grips

LAWN CARE

grass & leaf rakes

The Spear & Jackson Grass & Leaf Rake Range consists of a comprehensive range of plastic rakes perfectly designed for raking leaves, grass cuttings and garden rubbish over large areas.

Fan Rake 450mm Long Timber Handle



Part No	Type	Head Size	Pack Qty
SJ-R450	Fan Rake 450mm	450mm	10

- Ideal For Raking Leaves, Weeds & Grass Clippings
- Long Timber Handle
- 450mm Virgin Plastic Head and Tines
- Only sold in bundles of 10
- Made In Australia

Fan Rake 600mm Long Timber Handle



Part No	Type	Head Size	Pack Qty
SJ-R600	Fan Rake 600mm	600mm	10

- Ideal For Raking Leaves, Weeds & Grass Clippings
- Long Timber Handle
- 600mm Virgin Plastic Head and Tines
- Only sold in bundles of 10
- Made In Australia

Fan Rake - All Metal Adjustable Metal Tines



Part No	Type	Head Size	Pack Qty
SJ-AFR1	Rake - Adjustable	480mm	12

- Ideal For Raking Leaves, Weeds & Grass Clippings
- Fully Adjustable 15 Tine Steel Head
- Adjusts From 7" (175mm) to 24" (600mm)
- Lightweight Steel Shaft
- PVC Grip
- Hangable For Easy Storage



Rake - Spreader Bar

Long Steel Handle

The Spear and Jackson 600mm Rake with Spreader Bar features a durable, poly head and tines with a strong PVC coated metal handle. Its lightweight design makes it an excellent choice for raking leaves, grass cuttings and garden rubbish over large areas.

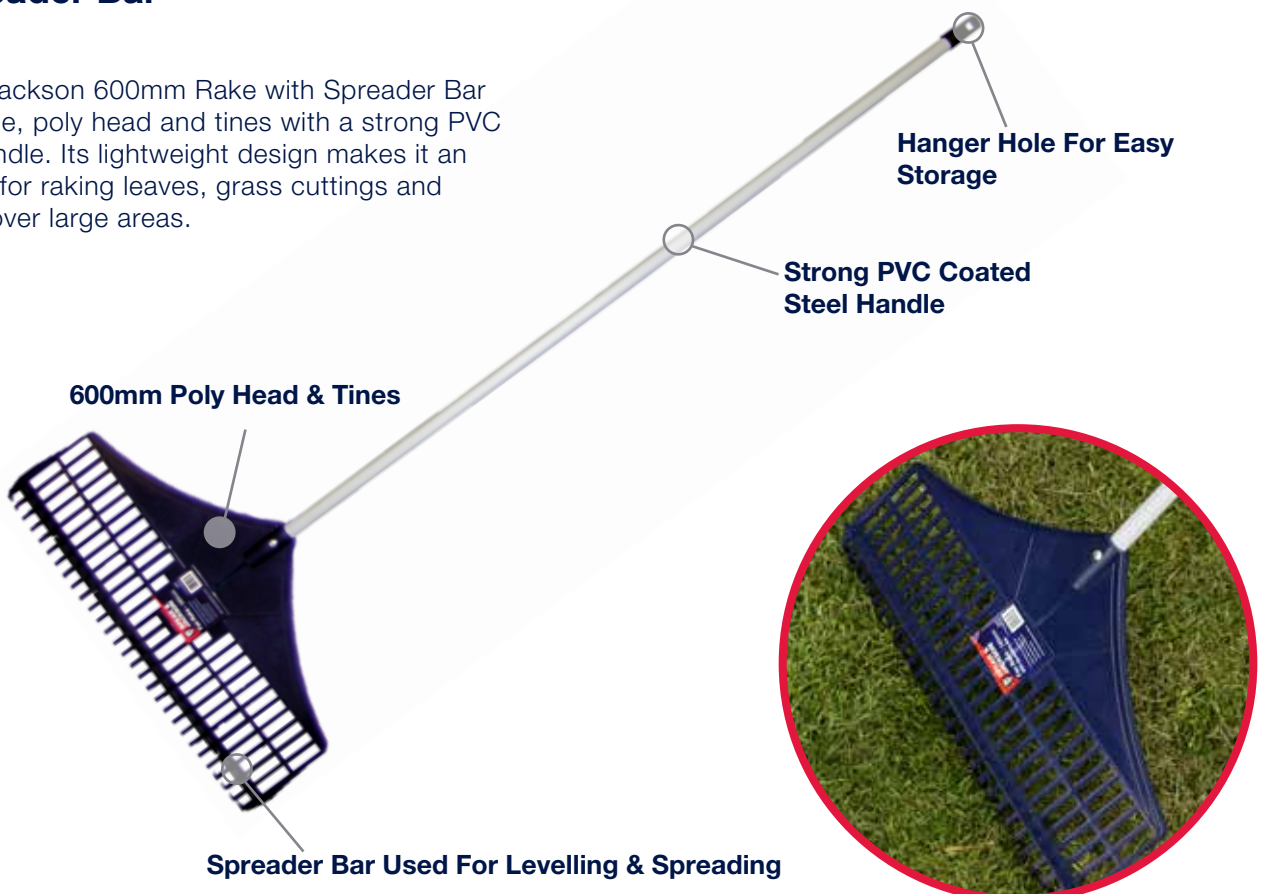

LAWN CARE

grass & leaf rakes

Spreader Bar Rake

Long Steel Handle



Part No	Type	Head Size	Pack Qty
SJ-SFR1	Rake with Spreader	600mm	12

- Ideal For Raking Leaves, Grass Cuttings & Garden Rubbish Over Large Areas
- Spreader Bar Used For levelling & Spreading
- Hard Wearing Poly Head and Tines
- Lightweight design
- Strong long handle

Fan Rake Deluxe

Steel Handle - Telescopic



Part No	Type	Head Size	Pack Qty
SJ-FRTS1	Telescopic Rake	480mm	5

- Ideal For Raking Leaves, Grass Cuttings & Garden Rubbish Over Large Areas
- Lightweight Telescopic Steel Shaft for Easy Storage
- Replaceable Heavy Duty Flexible Tines
- Comes with 6 Spare Tines

Fan Rake - Soft Grip

Long Steel Handle



Part No	Type	Head Size	Pack Qty
SJ-FR1	Rake - Adjustable	600m	5

- Ideal For Raking Leaves, Grass Cuttings & Garden Rubbish Over Large Areas
- Lightweight Steel Shaft
- Long Comfort Soft Grip
- Extra Tough Heavy Duty Flexible Tines and Head
- Hangable for Easy Storage



The Spear & Jackson Fan Rake Soft Grip Features Extremely Durable Plastic Tines & Head. Its' Long Comfortable Soft Grip Handle Makes Raking Easier Than Ever Before.

Fan Rake Deluxe

Steel Telescopic Handle

The Spear & Jackson Fan Rake Deluxe features a steel telescopic handle which allows for easy storage after use. Equipped with 23 strong replaceable plastic tines and an extra 6 supplied with each product the Fan Rake Deluxe is the perfect tool for all your lawn care needs.



"Supplied with 6 spare tines"

Hanger Hole For Easy Storage

Steel Telescopic Handle

1150MM

23 Replaceable Plastic Tines

650MM

LAWN CARE sprayers & accessories

500ml Trigger Sprayer



Part No	Type	Size	Pack Qty
SJ-P723	Sprayer - Trigger Action - 0.5lt	200mm x 100mm	100

- Polypropylene Body
- Viton Seals
- Adjustable Nozzle
- All Componets Are Made From Corrosion-Resistant Materials
- Mist & Strong Jet Spray Options
- Designed To Be Used With Some Chemicals

1 Litre Trigger Sprayer



Part No	Type	Size	Pack Qty
SJ-P722	Sprayer - Trigger Action - 1lt	260mm x 120mm	60

- Polypropylene Body
- Viton Seals
- Adjustable Nozzle
- All Componets Are Made From Corrosion-Resistant Materials
- Mist & Strong Jet Spray Options
- Designed To Be Used With Some Chemicals

Flower Garden



Shrubs & Trees



1 Litre Pressure Sprayer



Part No	Type	Size	Pack Qty
SJ-P7240	Sprayer - Pressure - 1lt	260mm x 120mm	24

- Corrosion Free 1 Litre Polyethylene Tank
- Pump Action Pressure Sprayer
- Easy Use Thumb Trigger
- Measuring Scale On Bottle
- Optimum Working Pressure 50-70psi
- Intended For Use With Most Insecticides, Weed Killers, Fertilizers, Germicides, Fungicides, Herbicides, Detergents & Cleaning Solutions

2 Litre Pressure Sprayer



Part No	Type	Size	Pack Qty
SJ-P7250	Sprayer - Pressure - 2lt	350mm x 150mm	12

- Corrosion Free 2 Litre Polyethylene Tank
- Pump Action Pressure Sprayer
- Easy Use Thumb Trigger
- Measuring Scale On Bottle
- Optimum Working Pressure 50-70psi
- Intended For Use With Most Insecticides, Weed Killers, Fertilizers, Germicides, Fungicides, Herbicides, Detergents & Cleaning Solutions

5 Litre Pressure Sprayer



Part No	Type	Size	Pack Qty
SJ-SPY/500	5L Pressure Sprayer	480mm x 160mm	6

- Corrosion Free 5 Litre Polyethylene Tank
- Dual Action Carry Handle & Pump
- Trigger Operated
- Chrome Plated Brass Lance
- Optimum Working Pressure 50-70psi
- Intended For Use With Most Insecticides, Weed Killers, Fertilizers, Germicides, Fungicides, Herbicides, Detergents & Cleaning Solutions

Hose Tidy Plastic



Part No	Type	Size	Pack Qty
SJ-P730	Hose Tidy - Plastic	240mm x 145mm	60

- Reduces the likelihood of your hose kinking and twisting
- Durable Plastic Construction
- With Fixing Holes

Hose Tidy Metal



Part No	Type	Size	Pack Qty
SJ-P725	Hose Tidy - Metal	260mm x 135mm	25

- Reduces the likelihood of your hose kinking and twisting
- Durable Metal Construction
- Powder Coated
- With Fixing Holes

Lawn Care



Masonry Spraying



SELECT

range

Select stainless steel digging and cultivating garden tools combine 250 years of experience with the latest in ergonomic design, manufacturing technology and materials to produce a range of contemporary tools at highly affordable prices with a universal appeal.



SELECT garden digging

STAINLESS



Extra wide handle for comfort

Polypropylene shaft with integral ergonomic forward tilting handle



Mirror polished stainless steel head for rust resistance and minimal soil adhesion

Digging Spade



Digging Fork



Border Spade



Border Fork



Part No	Type	Head Size	Pack Qty
SJ-1190EL	Digging Spade	290mm x 180mm	5

- Mirror Polished Stainless Steel Head For Rust Resistance & Minimal Soil Adhesion
- Polypropylene Shaft With Integral Ergonomic Forward Tilting Extra Wide Handle
- Manufactured To Exceed BS3388 British Standard Load Tests

Part No	Type	Head Size	Pack Qty
SJ-1990EL	Digging Fork	300mm x 180mm	5

- Mirror Polished Stainless Steel Head For Rust Resistance & Minimal Soil Adhesion
- Polypropylene Shaft With Integral Ergonomic Forward Tilting Extra Wide Handle
- Manufactured To Exceed BS3388 British Standard Load Tests

Part No	Type	Head Size	Pack Qty
SJ-1194EL	Border Spade	230mm x 145mm	5

- Mirror Polished Stainless Steel Head For Rust Resistance & Minimal Soil Adhesion
- Polypropylene Shaft With Integral Ergonomic Forward Tilting Extra Wide Handle
- Manufactured To Exceed BS3388 British Standard Load Tests

Part No	Type	Head Size	Pack Qty
SJ-1994EL	Border Fork	240mm x 140mm	5

- Mirror Polished Stainless Steel Head For Rust Resistance & Minimal Soil Adhesion
- Polypropylene Shaft With Integral Ergonomic Forward Tilting Extra Wide Handle
- Manufactured To Exceed BS3388 British Standard Load Tests

SELECT cultivating

Dutch Hoe



Part No	Type	Head Size
SJ-DHE1	Dutch Hoe Soft Grip	130mm x 70mm

- Designed For Chipping, Weeding, Cultivating & Mulching
- Lightweight Ergonomic Steel Shaft
- Unique Modern Ergo Design
- Powder Coated Carbon Steel Head
- Comfort Soft Touch End & Centre Grips

Poly Lawn Rake



Pack Qty	Part No	Type	Head Size
5	SJ-PLRE1	Poly Lawn Rake	600mm x 265mm

- Designed For Raking & Clearing From Grass/Lawn Areas
- Polypropylene Head
- 29 Flexible Tines (600mm)
- Curved Ergonomic Handle
- Middle Grip for Extra Comfort



Curved ergonomic handle designed for comfort and to reduce back strain during use

Soil Rake

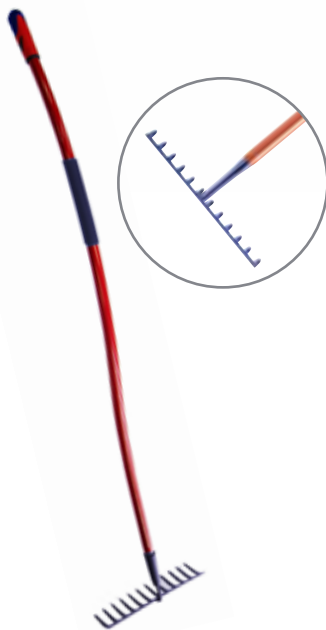

Part No	Type	Head Size
SJ-GRE1	Soil Rake Soft Grip	350mm x 100mm

- Designed For Moving / Spreading Soil & Small Stones
- Lightweight Ergonomic Steel Shaft
- Unique Modern Ergo Design
- Powder Coated Carbon Steel Head
- Comfort Soft Touch End & Centre Grips

Swan Neck Hoe



Pack Qty	Part No	Type	Head Size
5	SJ-SHE1	Swan Neck Soft Grip	140mm x 80mm

- Designed For Deeper Hoeing & Cultivating
- Lightweight Ergonomic Steel Shaft
- Unique Modern Ergo Design
- Powder Coated Carbon Steel Head
- Comfort Soft Touch End & Centre Grips

3 Prong Cultivator

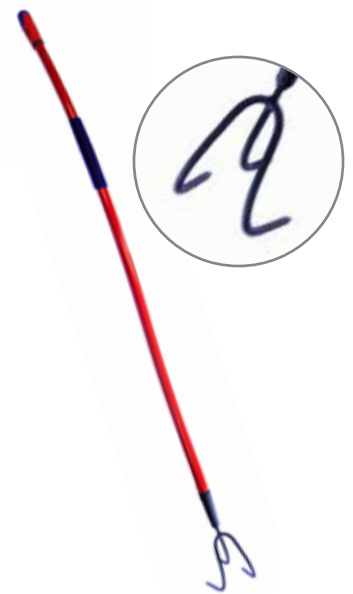

Pack Qty	Part No	Type	Head Size	Pack Qty
5	SJ-CE1	Cultivator 3 Prong Soft Grip	3 Prongs	5

- Designed For Cultivating & General Garden Maintenance
- Lightweight Ergonomic Steel Shaft
- Unique Modern Ergo Design
- Powder Coated Carbon Steel Head
- Comfort Soft Touch End & Centre Grips

SELECT hand tools

STAINLESS

Hand Trowel



Weed Fork



Edging Knife



Part No	Type	Overall Size	Pack Qty
SJ-3058EL	Hand Trowel	12"	5

- Mirror Polished Stainless Steel Head For Rust Resistance And Minimal Soil Adhesion
- Bi-material Contoured Handle
- Tanged For Knuckle Clearance



Part No	Type	Overall Size	Pack Qty
SJ-3053EL	Weed Fork	12"	5

- Mirror Polished Stainless Steel Head For Rust Resistance And Minimal Soil Adhesion
- Bi-material Contoured Handle
- Tanged For Knuckle Clearance



Part No	Type	Head Size	Pack Qty
SJ-3164EL	Edging Knife	210mm x 110mm	5

- Ideal For Lawn Edges And Turf Cutting
- Mirror Polished Stainless Steel Head for Rust Resistance & Minimal Soil Adhesion
- Treaded Blade for Comfort
- Lightweight Aluminium Shaft
- Soft Grip T Handle



Select Stainless 4pc



with gloves and twine

Part No	Type	Pack Qty
SJ-TWINESET3	Select 4pc Gift Set	5

- Contains: Hand Trowel, Weed fork, Gloves & Twine
- Mirror Polished Stainless Heads For Rust Resistance & Minimal Soil Adhesion
- Ergonomic Soft Feel Handles
- Tanged For Knuckle Clearance
- Hard Wearing "Rigger" Style Garden Gloves
- 100m of Jute Garden Twine

Leaf Grabber



Part No	Type	Head Size	Pack Qty
SJ-LG1	Leaf Grabber	500mm	4

- Designed For Collecting Leaves and Grass Clippings
- 500mm (19 1/2") Wide Collecting Blades
- Overall Length Of 920mm (36") Which Allows User To Collect Leaves Without Needing To Bend Over
- Non-Slip Grips

Litter Picker



Part No	Type	Pack Qty
SJ-LITTERPICKER	Litterpicker 1070mm	5

- 1070mm (42") Long Handle For Extra Reach
- Firm, Clean Claw Action
- Locking Catch For Safer Storage

TRADITIONAL

range

The Traditional range of digging and cultivating tools has been created by combining modern and natural materials to create a timeless classic. Each product is produced with a mirror polished Stainless Steel head which provides reduction in soil adhesion.

The Spear & Jackson Traditional Range are fitted with weatherproofed hardwood handles, and create an attractive, highly functional range of tools for those gardeners who prefer the 'Traditional' look.



TRADITIONAL digging

STAINLESS

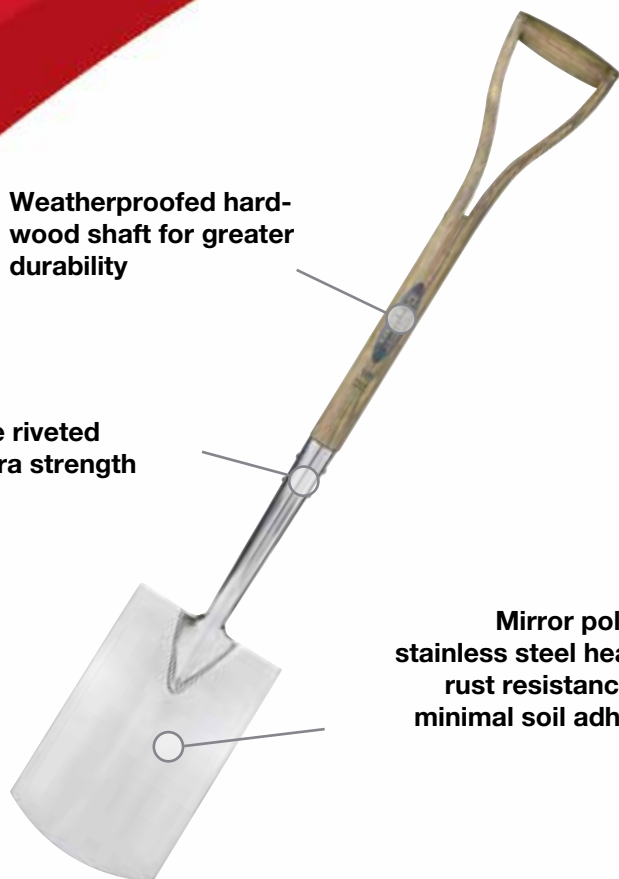

Weatherproofed hard-wood shaft for greater durability

Double riveted for extra strength

Mirror polished stainless steel head for rust resistance and minimal soil adhesion



Digging Spade



Digging Fork



Border Spade



Border Fork



Part No **Type** **Head Size** **Pack Qty**
SJ-4450DS Digging Spade 290mm x 180mm 5
 • Mirror Polished Stainless Steel Head For Rust Resistance And Minimal Soil Adhesion
 • Weatherproofed Hardwood Shaft For Greater Durability
 • One-Piece Hardwood Shaft, Split To Form A Wishbone Handle

Part No **Type** **Head Size** **Pack Qty**
SJ-4550DF Digging Fork 300mm x 180mm 5
 • Mirror Polished Stainless Steel Head For Rust Resistance And Minimal Soil Adhesion
 • Weatherproofed Hardwood Shaft For Greater Durability
 • One-Piece Hardwood Shaft, Split To Form A Wishbone Handle

Part No **Type** **Head Size** **Pack Qty**
SJ-4454BS Border Spade 230mm x 145mm 5
 • Mirror Polished Stainless Steel Head For Rust Resistance And Minimal Soil Adhesion
 • Weatherproofed Hardwood Shaft For Greater Durability
 • One-Piece Hardwood Shaft, Split To Form A Wishbone Handle

Part No **Type** **Head Size** **Pack Qty**
SJ-4552BF Border Fork 240mm x 140mm 5
 • Mirror Polished Stainless Steel Head For Rust Resistance And Minimal Soil Adhesion
 • Weatherproofed Hardwood Shaft For Greater Durability
 • One-Piece Hardwood Shaft, Split To Form A Wishbone Handle

TRADITIONAL hand tools

STAINLESS



Trowel 5 1/2" Handle



Part No	Type	Handle Length	Pack Qty
SJ-5030TR	Hand Trowel	140mm	5

- Mirror Polished Stainless Steel Head For Rust Resistance and Minimal Soil Adhesion
- Weatherproofed Hardwood Handle For Greater Durability
- Tanged For Knuckle Clearance
- Leather Wrist Strap

Weed Fork 5 1/2" Handle



Part No	Type	Handle Length	Pack Qty
SJ-5040WF	Weed Fork	140mm	5

- Mirror Polished Stainless Steel Head For Rust Resistance and Minimal Soil Adhesion
- Weatherproofed Hardwood Handle For Greater Durability
- Tanged For Knuckle Clearance
- Leather Wrist Strap

Trowel Transplanting



Part No	Type	Handle Length	Pack Qty
SJ-5080TT	Transplanting Trowel	140mm	5

- Mirror Polished Stainless Steel Head For Rust Resistance and Minimal Soil Adhesion
- Weatherproofed Hardwood Handle For Greater Durability
- Tanged For Knuckle Clearance
- Leather Wrist Strap

Soil Scoop



Part No	Type	Handle Length	Pack Qty
SJ-5060SS	Soil Scoop	140mm	5

- Mirror Polished Stainless Steel Head For Rust Resistance and Minimal Soil Adhesion
- Weatherproofed Hardwood Handle For Greater Durability
- Tanged For Knuckle Clearance
- Leather Wrist Strap

Trowel 12" Handle



Part No	Type	Handle Length	Pack Qty
SJ-5010TR	Hand Trowel	280mm	5

- Mirror Polished Stainless Steel Head For Rust Resistance and Minimal Soil Adhesion
- Weatherproofed Hardwood Handle For Greater Durability
- Tanged For Knuckle Clearance
- Leather Wrist Strap

Weed Fork 12" Handle



Part No	Type	Handle Length	Pack Qty
SJ-5110WF	Weed Fork	280mm	5

- Mirror Polished Stainless Steel Head For Rust Resistance and Minimal Soil Adhesion
- Weatherproofed Hardwood Handle For Greater Durability
- Tanged For Knuckle Clearance
- Leather Wrist Strap

3 Prong Cultivator



Part No	Type	Handle Length	Pack Qty
SJ-5210PC	3 Prong Cultivator	280mm	5

- Mirror Polished Stainless Steel Head For Rust Resistance and Minimal Soil Adhesion
- Weatherproofed Hardwood Handle For Greater Durability
- Tanged For Knuckle Clearance
- Leather Wrist Strap

Daisy Grubber



Part No	Type	Handle Length	Pack Qty
SJ-5070DG	Daisy Grubber	140mm	5

- Mirror Polished Stainless Steel Head For Rust Resistance and Minimal Soil Adhesion
- Weatherproofed Hardwood Handle For Greater Durability
- Tanged For Knuckle Clearance
- Leather Wrist Strap

Traditional 3pc



Contains:
Hand Trowel,
Weed Fork
& Transplanter

Part No	Type	Pack Qty
SJ-TRAD3PCS	Traditional 3pc Gift Set	10

- Mirror Polished Stainless Steel Head For Rust Resistance and Minimal Soil Adhesion
- Weatherproofed Hardwood Handle For Greater Durability
- Tanged For Knuckle Clearance
- Leather Wrist Strap



NEVERBEND

range

The range of Neverbend® Stainless garden tools has also benefited from a change of livery. Each product is produced with a mirror polished Stainless Steel head which provides reduction in soil adhesion.

The Supergrip® handle is tilted to provide the user with the best possible digging angle. A comfortable soft grip and hardwood handle complete this concise, professional range of digging tools.



Supergrip® handle forward tilt gives the ideal digging angle



Mirror polished stainless steel head for rust resistance and minimal soil adhesion

Digging Spade



Digging Fork



Border Spade



Border Fork



Part No	Type	Head Size	Pack Qty
SJ-1160SP	Digging Spade	290mm x 180mm	5

- Mirror Polished Stainless Steel Head For Rust Resistance And Minimal Soil Adhesion
- Extra Long Socket For Added Strength
- Weatherproofed Hardwood Shaft For Greater Durability
- Supergrip® Handle - Forward Tilt Gives The Ideal Digging Angle

Part No	Type	Head Size	Pack Qty
SJ-1560SF	Digging Fork	290MM x 185MM	5

- Mirror Polished Stainless Steel Head For Rust Resistance And Minimal Soil Adhesion
- Extra Long Socket For Added Strength
- Weatherproofed Hardwood Shaft For Greater Durability
- Supergrip® Handle - Forward Tilt Gives The Ideal Digging Angle

Part No	Type	Head Size	Pack Qty
SJ-1161BS	Border Spade	230mm x 145mm	5

- Mirror Polished Stainless Steel Head For Rust Resistance And Minimal Soil Adhesion
- Extra Long Socket For Added Strength
- Weatherproofed Hardwood Shaft For Greater Durability
- Supergrip® Handle - Forward Tilt Gives The Ideal Digging Angle

Part No	Type	Head Size	Pack Qty
SJ-1561BF	Border Fork	230mm x 140mm	5

- Mirror Polished Stainless Steel Head For Rust Resistance And Minimal Soil Adhesion
- Extra Long Socket For Added Strength
- Weatherproofed Hardwood Shaft For Greater Durability
- Supergrip® Handle - Forward Tilt Gives The Ideal Digging Angle

Hand Trowel



Weed Fork



Transplanting Trowel



Part No	Type	Handle Length	Pack Qty
SJ-3010TR	Hand Trowel	5"	10

- Handle Length 127mm (5")
- Mirror Polished Stainless Steel Head For Rust Resistance & Minimal Soil Adhesion
- Weatherproofed Hardwood Handle For Greater Durability
- Stainless Steel Ferrule
- Tanged For Knuckle Clearance

Part No	Type	Handle Length	Pack Qty
SJ-3060WF	Weed Fork	5"	10

- Handle Length 127mm (5")
- Mirror Polished Stainless Steel Head For Rust Resistance & Minimal Soil Adhesion
- Weatherproofed Hardwood Handle For Greater Durability
- Stainless Steel Ferrule
- Tanged For Knuckle Clearance

Part No	Type	Handle Length	Pack Qty
SJ-3020SP	Transplanting Trowel	5"	10

- Handle Length 127mm (5")
- Mirror Polished Stainless Steel Head For Rust Resistance & Minimal Soil Adhesion
- Weatherproofed Hardwood Handle For Greater Durability
- Stainless Steel Ferrule
- Tanged For Knuckle Clearance



E-SERIES

range

A range of ergonomically designed innovative digging and hand tools incorporating features such as enlarged, forward tilting handles and centralised foot treads on spades and forks

Lightweight ergonomic handles with a comfortable D-Handle grip. The result is easier gardening with less strain.



E-SERIES digging



Ergonomic forward tilting handle
for comfortable use at the ideal digging angle

Centralised foot tread
- reduces slippage and unbalance
- delivers more digging power with less muscle effort and strain



Digging Spade

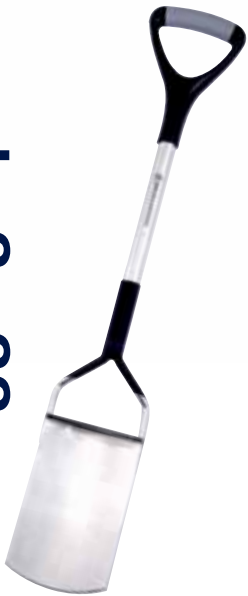

Part No	Type	Head Size	Pack Qty
SJ-7301DS	Digging Spade	295mm x 180mm	5

- Heat Treated (Hardened) Stainless Steel Head & Stirrup For Strength And Durability
- Mirror Polished Stainless Steel Head For Rust Resistance And Minimal Soil Adhesion
- Tubular Stainless Steel Shaft For Rust Resistance
- Soft-Feel Lower Shaft For Comfortable Safe Use and Extra Grip
- Large Soft-Feel Handle For A Comfortable Two-Handed Grip When Digging In Hard Ground

Digging Fork



Part No	Type	Head Size	Pack Qty
SJ-7302DF	Digging Fork	305mm x 180mm	5

- Heat Treated (Hardened) Stainless Steel Head & Stirrup For Strength And Durability
- Mirror Polished Stainless Steel Head For Rust Resistance And Minimal Soil Adhesion
- Tubular Stainless Steel Shaft For Rust Resistance
- Soft-Feel Lower Shaft For Comfortable Safe Use and Extra Grip
- Large Soft-Feel Handle For A Comfortable Two-Handed Grip When Digging In Hard Ground

Hand Trowel



Part No	Type	Handle Length	Pack Qty
SJ-7309HT	Hand Trowel	6"	10

- Mirror Polished Stainless Steel Head For Rust Resistance And Minimal Soil Adhesion
- Soft-Feel Handle For Comfortable Use And Extra Grip

Weed Fork



Part No	Type	Handle Length	Pack Qty
SJ-7310WF	Weed Fork	6"	10

- Mirror Polished Stainless Steel Head For Rust Resistance And Minimal Soil Adhesion
- Soft-Feel Handle For Comfortable Use And Extra Grip

GARDEN DIGGING overview

Post Hole Shovels

Ideal For Digging Post Holes, Clearing And Mixing Work

Part No	Handle Type	Head Material	Pack Qty	Page No.
SJ-CGPH1	County Timber	Carbon Steel	6	4
SJ-SHO/75FG	County Fibreglass	Carbon Steel	6	9
SJ-OPHS	Trade Timber	Carbon Steel	6	10
SJ-FGPHS	Trade Fibreglass	Carbon Steel	6	11
SJ-SCPH	Solid Core	Carbon Steel	6	12



Square Mouth Shovels

Ideal For Shoveling Soils, Sand & Garden Materials.

Part No	Handle Type	Head Material	Pack Qty	Page No.
SJ-CGSH1L	County Timber	Carbon Steel	6	4
SJ-CGSH1	County Timber D-Handle	Carbon Steel	6	5
SJ-SHO/60FG	County Fibreglass	Carbon Steel	6	9
SJ-OSMS	Trade Timber	Carbon Steel	6	10
SJ-FGSMS	Trade Fibreglass	Carbon Steel	6	11
SJ-WS360L	All Steel	Carbon Steel	6	13
SJ-WS350	All Steel D-Handle	Carbon Steel	6	13



Plumbers Shovels

Ideal For Digging Drains, Holes & General Garden Jobs

Part No	Handle Type	Head Material	Pack Qty	Page No.
SJ-SHO/80FG	County Fibreglass	Carbon Steel	6	9
SJ-OPS	Trade Timber	Carbon Steel	6	10
SJ-FGPS	Trade Fibreglass	Carbon Steel	6	11
SJ-SCPS	Solid Core	Carbon Steel	6	12



Trenching Shovels

Ideal For Digging Trenches, Drains & Narrow Tasks

Part No	Handle Type	Head Material	Pack Qty	Page No.
SJ-CTS1L	County Timber	Carbon Steel	6	4
SJ-SHO/90FG	County Fibreglass	Carbon Steel	6	9
SJ-OTS	Trade Timber	Carbon Steel	6	10
SJ-FGTS	Trade Fibreglass	Carbon Steel	6	11



Round Mouth Shovels

Ideal For Digging, Shoveling, Spreading And Shifting

Part No	Handle Type	Head Material	Pack Qty	Page No.
SJ-CGSP1L	County Timber	Carbon Steel	6	4
SJ-CGSRMD	County Timber D-Handle	Carbon Steel	6	5
SJ-SHO/15FG	County Fibreglass	Carbon Steel	6	9
SJ-ORMS	Trade Timber	Carbon Steel	6	10
SJ-FGRMS	Trade Fibreglass	Carbon Steel	6	11



Spades

Ideal For Digging In Soils And Clay

Part No	Handle Type	Head Material	Pack Qty	Page No.
SJ-CGSP1	County Timber D-Handle	Carbon Steel	6	5
SJ-1071AL	MYD Timber Handle	Solid Forged	5	13
SJ-1190EL	Select Ergonomic D-Handle	Stainless Steel	5	18
SJ-4450DS	Traditional Timber D-Handle	Stainless Steel	5	22
SJ-1160SP	Neverbend SuperGrip D-Handle	Stainless Steel	5	25
SJ-7301DS	E-Series Ergonomic D-Handle	Stainless Steel	5	27



Forks

Ideal For Digging, Cultivating And Turning Over Soil

Part No	Handle Type	Head Material	Pack Qty	Page No.
SJ-CGF1	County Timber D-Handle	Carbon Steel	6	5
SJ-1570AL	MYD Timber Handle	Solid Forged	5	13
SJ-1990EL	Select Ergonomic D-Handle	Stainless Steel	5	18
SJ-4450DF	Traditional Timber D-Handle	Stainless Steel	5	22
SJ-1560SF	Neverbend SuperGrip D-Handle	Stainless Steel	5	25
SJ-7302DF	E-Series Ergonomic D-Handle	Stainless Steel	5	27



GARDEN CUTTING

The new Spear & Jackson Razorsharp® cutting tool range introduces a number of innovative new products designed to complement our existing lines, resulting in a totally comprehensive range of cutting tools with a logical price and quality hierarchy.

SECATEURS

Available in Bypass & Anvil designs Spear & Jackson Razorsharp Secateurs offers a diverse range of ratchet, twist action, adjustable and professional secateurs which are ideal for the every day gardener.

LOPPERS

The Spear & Jackson Razorsharp Loppers range offers both standard and telescopic loppers featuring both anvil and bypass cutting actions. The NEW Razorsharp Professional Loppers are designed for landscapers and true gardening professionals.

SHEARS

The Spear & Jackson Razorsharp Shears range consists of a comprehensive range of standard, wishbone and telescopic shears designed to suit the needs of the D.I.Y & professional gardener.

BOW SAWS & PRUNERS

This range offers both professional and great value products to service all of your customers needs. Introducing the NEW Predator Bow Saw range featuring 4 different types of saws and 2 types of blades the range is completed with a shelf ready merchadiser.

AXES & BLOCKSPLITTERS

Available in both Hickory Timber and Fibreglass handles the Spear & Jackson Axe and Blocksplitter range consists of 3 different sized axes, a large 6lb blocksplitter and 2 specially designed hatchets for all your cutting & camping needs.



RAZORSHARP secateurs



Innovation in technology has improved almost every aspect of our daily life. Now, the Razorsharp® Secateurs collection incorporates innovations such as geared and ratchet mechanisms, ergonomic design and new materials to make gardening so much easier and enjoyable.

Medium Bypass



19mm
(3/4")

Part No	Type	Max Cutting Cap.	Pack Qty
SJ-BS10	Bypass Secateur	19mm	12

- Max Cutting Diameter 19mm
- Quality Carbon Steel Blades
- Strong Lightweight Aluminium Body
- Comfort Soft Grip Handles
- Smooth Cutting Action

Medium Bypass



15mm
(5/8")

Part No	Type	Max Cutting Cap.	Pack Qty
SJ-7159BS	Bypass Secateur	15mm	5

- SK5 Carbon Steel Upper Blade For Lasting Sharpness
- PTFE Coated Upper Blade For Rust Resistance
- Hard Chromed Lower Blade For Rust Resistance
- Ergonomic Handles For Increased Comfort
- Ambidextrous Locking Catch

Adjustable Bypass



15mm
(5/8")

Part No	Type	Max Cutting Cap.	Pack Qty
SJ-6559BS	Bypass Secateur	15mm	5

- Two Adjustable Widths
- Smaller Handle Width Ideal For Ladies
- SK5 Carbon Steel Blades
- PTFE Coated Blades For Rust Resistance & Smooth Cutting
- Ergonomic Soft-Grip Handles



Ratchet Anvil



20mm
(3/4")

Part No	Type	Max Cutting Cap.	Pack Qty
SJ-6358RS	Anvil Secateur	20mm	5

- Ratchet Action Means Easy Pruning In 4 Short Steps
- High Carbon Steel Blade, PTFE Coated For Smooth Cutting
- Lightweight Cast Aluminium Body
- Metal Locking Catch



Ratchet Twist Anvil



20mm
(3/4")

Part No	Type	Max Cutting Cap.	Pack Qty
SJ-6458RS	Anvil Secateur	20mm	5

- Ratchet Action Means Easy Pruning In 4 Short Steps
- Auto-Rotating Lower Handle Helps Minimise Strain & Fatigue
- High Carbon Steel Blade, PTFE Coated For Smooth Cutting
- Lightweight Cast Aluminium Body



Anvil Secateurs Are designed to cut through dead stems, they have one blade which closes on to a flat surface. They are better for cutting hard woody stems as the blade is less likely to stick to the stem as it cuts.

Non-slip profiled handles for comfort during use

Metal locking catch

PTFE coated blades for easier cutting



Ratchet action means easy pruning in 4 easy steps

Loop handle for protection of fingers during use



Medium Bypass

Large Bypass

Medium Anvil



Part No	Type	Max Cutting Cap.	Pack Qty
SJ-6059BS	Bypass Secateur	15mm	5

- Medium Sized Handle
- SK5 Carbon Steel Blades
- Bi-Material Non-Slip Comfort Grips
- PTFE Coated Blades For Rust Resistance & Smooth Cutting
- Drop Nose Blades For Easier Pruning
- Contoured Ergonomic Handles
- Ambidextrous Locking Catch
- Sap Groove In Blade
- Shock Absorber
- Stem Crusher

Part No	Type	Max Cutting Cap.	Pack Qty
SJ-6060BS	Bypass Secateur	20mm	5

- Large Handle Suitable For Larger Hands
- SK5 Carbon Steel Blades
- Bi-Material Non-Slip Comfort Grips
- PTFE Coated Blades For Rust Resistance & Smooth Cutting
- Drop Nose Blades For Easier Pruning
- Contoured Ergonomic Handles
- Ambidextrous Locking Catch
- Sap Groove In Blade
- Shock Absorber
- Stem Crusher

Part No	Type	Max Cutting Cap.	Pack Qty
SJ-6058AS	Anvil Secateur	15mm	5

- Medium Sized Handle
- SK5 Carbon Steel Blades
- Bi-Material Non-Slip Comfort Grips
- PTFE Coated Blades For Rust Resistance & Smooth Cutting
- Drop Nose Blades For Easier Pruning
- Contoured Ergonomic Handles
- Ambidextrous Locking Catch
- Sap Groove In Blade
- Shock Absorber
- Stem Crusher

Ergo twist Bypass

Premium Bypass

6 in 1 Blade Sharpener



Part No	Type	Max Cutting Cap.	Pack Qty
SJ-6259BS	Bypass Secateur	15mm	5

- Auto-Rotating Lower Handle Helps Minimise Strain and Fatigue
- SK5 High Carbon Steel Blades
- Stepped Locking Catch For Either Wide Or Narrow Cutting Width
- PTFE Coated For Smooth Cutting
- Lightweight Cast Aluminium Body

Part No	Type	Max Cutting Cap.	Pack Qty
SJ-6160BS	Bypass Secateur	15mm	5

- SK5 High Carbon Steel Blades
- Ergonomic Lightweight Aluminium Handles
- Adjustable Hand-Opening For Individual User Comfort
- PTFE Coated For Smooth Cutting & Rust Resistance

Part No	Type	Pack Qty
SJ-4056BS	6 In 1 Blade Sharpener	5

- Ideal For Sharpening Secateurs, Shears, Loppers Scissors, Knives And Other Small Cutting Tools
- 4 Sharpening Options To Cover A Wide Range Of Different Blade Types
- Cleaning Sponge And Lubricating/Anti-Corrosion Oil Stored Inside Handle
- Soft-Feel Non-Slip Grip
- Built-In Hand Guard



Bypass Secateurs Are designed to prune live stems, the two blades work like a pair of scissors with the blades passing each other to make the cut. They are suitable for cutting delicate stems as the action is less likely to cause bruising to the stem.

How To Sharpen Your Blade

- Secure The Tool To Be Sharpened Either In A Vice Or Held Against A Firm Surface, With The Edge Of The Blade Facing Upright.
- Select Optimum Sharpener Based On Icons Printed On The Handle.
- Press Down Firmly And Pull The Sharpener Towards Yourself Running It From One Edge Of The Blade To The Other, Usually 4 To 5 Strokes Will Be Sufficient.
- Cleaning Sponge And Anti Rust Oil Are Provided To Wipe Down Sharpened Blade.

RAZORSHARP PRO secateurs



The new Spear & Jackson Razorsharp® PRO cutting tool range of loppers & secateurs has been designed to satisfy the needs of professional gardeners and landscapers. Competitively priced, the range features drop forged carbon steel interchangeable blades, forged aluminium handles for strength and durability and adjustable blade tensioning.

Heavy Duty Bypass



◀ 20mm
(3/4") ▶

Short Blade Bypass



◀ 20mm
(3/4") ▶

Ergo Bypass



◀ 20mm
(3/4") ▶

Spare Blade & Spring Bypass



SPECIAL ORDER ONLY

Part No	Type	Max Cutting Cap.	Pack Qty
SJ-6659BS	Bypass Secateur	20mm	5
<ul style="list-style-type: none"> • SK5 High Carbon Steel Blades • Forged Aluminium Handle Construction • Sap Groove & Riveted Lower Blade • Rubber Shock Absorber • Notched Blade For Thicker Stems 			

Part No	Type	Max Cutting Cap.	Pack Qty
SJ-6657BS	Bypass Secateur	20mm	5
<ul style="list-style-type: none"> • SK5 High Carbon Steel Blades • Forged Aluminium Handle Construction • Sap Groove & Riveted Lower Blade • Rubber Shock Absorber • Notched Blade For Thicker Stems 			

Part No	Type	Max Cutting Cap.	Pack Qty
SJ-6959BS	Bypass Secateur	20mm	5
<ul style="list-style-type: none"> • SK5 High Carbon Steel Blades • Forged Aluminium Handle Construction • Sap Groove & Riveted Lower Blade • Rubber Shock Absorber • Notched Blade For Thicker Stems 			

Part No	Suits Model Type	Pack Qty
SJ-6659BLADE	SJ-6659BS	5
SJ-6657BLADE	SJ-6657BS	5
SJ-6959BLADE	SJ-6959BS	5
<ul style="list-style-type: none"> • Drop Forged, High Carbon Steel Blade • Blade Notch For Cutting Thicker Stems • Blade Change Instructions Supplied 		

RAZORSHARP PRO loppers

Heavy Duty 23½" (600mm) Bypass



◀ 32mm
(1.26") ▶

10
YEAR
GUARANTEE

Heavy Duty 27½" (700mm) Bypass



◀ 32mm
(1.26") ▶

10
YEAR
GUARANTEE

Heavy Duty Blade Bypass



SPECIAL ORDER ONLY

Part No	Type	Max Cutting Cap.	Handle Length	Pack Qty
SJ-8310RS	Bypass Lopper H/D	32mm	600mm	5
<ul style="list-style-type: none"> • Drop Forged, Carbon Steel Blades • Forged Aluminium Handle End Caps • Lightweight But Strong Aluminium Handles • Adjustable Blade Tension • Shock Absorbers • Soft Feel Non-Slip Grips 				

Part No	Type	Max Cutting Cap.	Handle Length	Pack Qty
SJ-8330RS	Bypass Lopper H/D	32mm	700mm	5
<ul style="list-style-type: none"> • Drop Forged, Carbon Steel Blades • Forged Aluminium Handle End Caps • Lightweight But Strong Aluminium Handles • Adjustable Blade Tension • Shock Absorbers • Soft Feel Non-Slip Grips 				

Part No	Suits Model Types	Pack Qty
SJ-8310BLADE	SJ-8310RS & SJ-8330RS	5
<ul style="list-style-type: none"> • Drop Forged, Carbon Steel Blade • Allen Key & Replacement Screws Included • Blade Change Instructions Supplied 		

RAZORSHARP loppers



18" Bypass Mini



Part No	Type	Max Cutting Cap.	Pack Qty
SJ-8230RS	Mini Lopper	33mm	5

- Bypass Action to Minimise Stem Bruising for Green Stems
- PTFE Coated C50 Carbon Steel Blades
- Lightweight Aluminium Handles
- Shock Absorbers
- Ergonomic Soft-Feel Grips

22" Bypass



Part No	Type	Max Cutting Cap.	Pack Qty
SJ-8010RS	Bypass Lopper	38mm	5

- C50 Carbon Steel Blades, Hardened And Tempered For Durability
- PTFE Coated Blade For Rust Resistance And Smooth Cutting
- Non-Slip Comfort Grips
- Lightweight Aluminium Handles

22" Anvil



Part No	Type	Max Cutting Cap.	Pack Qty
SJ-8020RS	Anvil Lopper	38mm	5

- C50 Carbon Steel Blades, Hardened And Tempered For Durability
- PTFE Coated Blade For Rust Resistance And Smooth Cutting
- Non-Slip Comfort Grips
- Lightweight Aluminium Handles

27" Bypass



Part No	Type	Max Cutting Cap.	Pack Qty
SJ-8030RS	Bypass Lopper	42mm	5

- C50 Carbon Steel Blades, Hardened And Tempered For Durability
- PTFE Coated Blade For Rust Resistance And Smooth Cutting
- Non-Slip Comfort Grips
- Lightweight Aluminium Handles

Telescopic Bypass

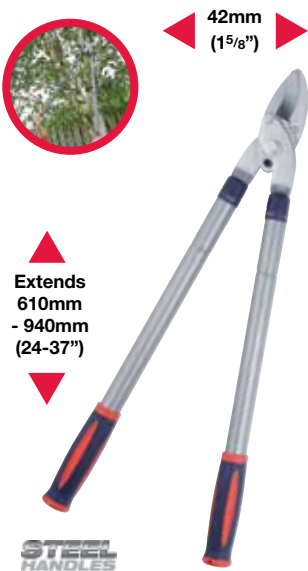

Part No	Type	Max Cutting Cap.	Pack Qty
SJ-4903RSS	Bypass Lopper	42mm	5

- Polished And Lacquered Blades For Rust Resistance And Smooth Cutting
- Tubular Steel Handles For Maximum Strength
- PVC Coated For Rust Resistance & Durability
- Twist And Lock Telescopic Mechanism
- Soft-Feel Grips

Geared Bypass 28"



Part No	Type	Max Cutting Cap.	Pack Qty
SJ-8210RS	Geared Lopper	38mm	5

- Geared Action Adds Extra Power For Effortless Cutting
- PTFE Coated C50 Carbon Steel Blades
- Lightweight Ergonomic Aluminium Handles
- Geared Cutting Action

Advanced Anvil 26"



Part No	Type	Max Cutting Cap.	Pack Qty
SJ-8160RS	Anvil Lopper	45mm	5

- PTFE Coated Anvil For Rust Resistance And Smooth Cutting
- Non-Slip Comfort Grips
- Lightweight Aluminium Handles
- Serrated Anvil For Extra Grip When Cutting, Minimising Twisting Action

Telescopic Ratchet Bypass



Part No	Type	Max Cutting Cap.	Pack Qty
SJ-8090RS	Bypass Lopper	42mm	5

- Twist And Lock Extendable Mechanism
- C50 Carbon Steel Blades, Hardened And Tempered For Durability
- PTFE Coated Blade For Rust Resistance And Smooth Cutting
- Non-Slip Comfort Grips
- Lightweight Aluminium Handles

RAZORSHARP shears



The Spear & Jackson Razorsharp Shears range consists of a comprehensive range of standard, wishbone and telescopic shears designed to suit the needs of the D.I.Y & professional gardener.

Standard 8" Timber Handle



Blade length
203mm
(8")

Part No	Type	Blade Length	Pack Qty
SJ-4875RSS	8" Standard	203mm	5

- Blade Notched For Cutting Thicker Stems
- Hollow Ground C50 Carbon Steel Blades For Lasting Sharpness
- Solid Hardwood Handles
- Chrome Plated Blades For Rust Resistance

Wishbone 8" Timber Handle



Blade length
203mm
(8")

Part No	Type	Blade Length	Pack Qty
SJ-4868SS	8" Wishbone	203mm	5

- Blade Notched For Cutting Thicker Stems
- Chrome Plated Blades For Rust Resistance
- Ergonomically Designed Wishbone Shaped, Weatherproofed Hardwood Handles

Wishbone 9" Ergonomic Handle



Blade length
230mm
(9")

Part No	Type	Blade Length	Pack Qty
SJ-4888HS	9" Wishbone	230mm	5

- Blade Notched For Cutting Thicker Stems
- Chrome Plated Blades For Rust Resistance
- Ergonomically Designed Wishbone Handles
- Shock Absorbing Bumpers
- Adjustable Tensioning Nut
- Chrome Plated C50 Carbon Steel Blade

Wishbone 9" Ergonomic Handle

With these ergonomic 'wishbone' shears, trimming shrubs and bushes will become a lot easier, giving you a precise, clean cut every time. Featuring shock absorbing bumpers, adjustable tensioning nut, ergonomic grips and a notched blade for cutting thicker stems.

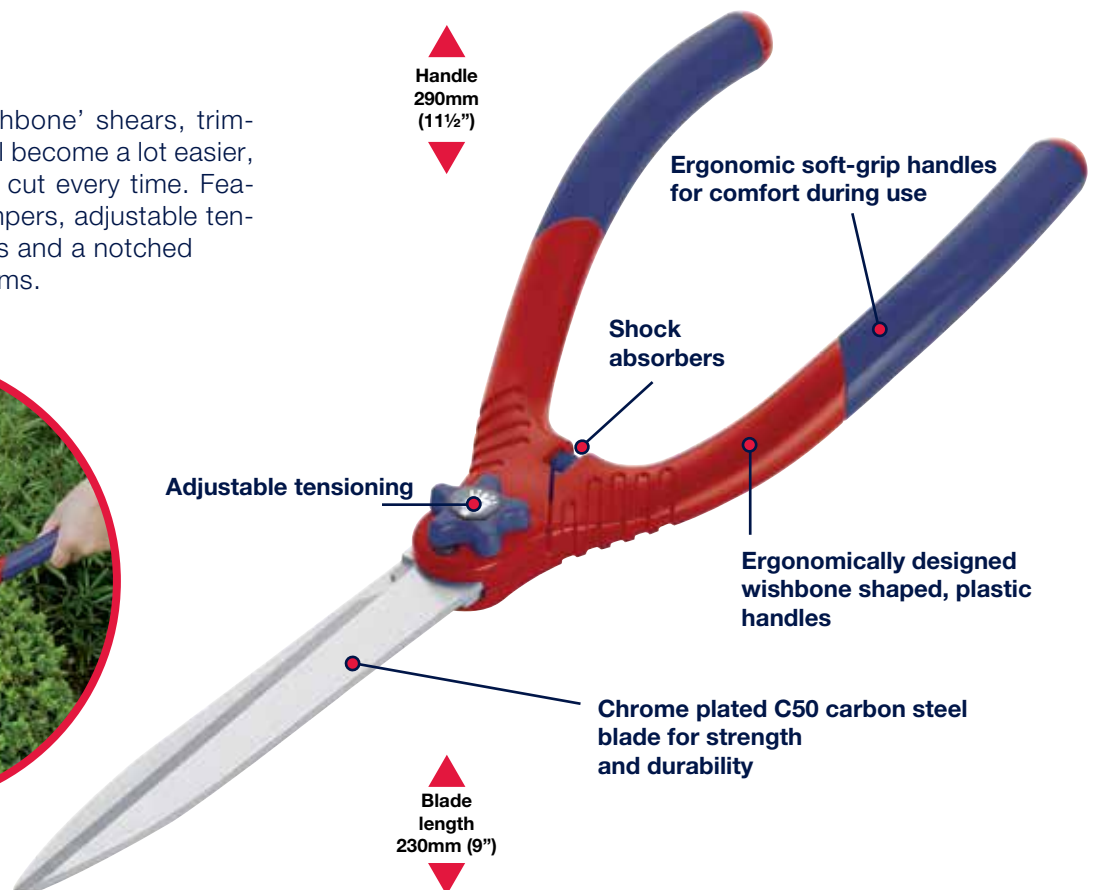

RAZORSHARP shears



Standard 9" Soft Grip Handle

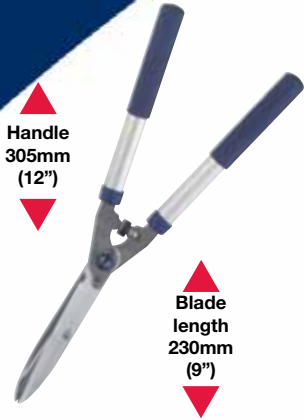

Part No	Type	Blade Length	Pack Qty
SJ-8110RS	9" Standard	230mm	5

- Chrome Plated Blades For Rust Resistance
- Blade Notched For Cutting Thicker Stems
- Shock Absorber
- Soft-Feel Grips

Telescopic 9" Soft Grip Handle



Part No	Type	Blade Length	Pack Qty
SJ-8120RS	9" Telescopic	230mm	5

- Adjustable Blade Tension Nut
- Lightweight Aluminium Telescopic Handles
- Twist And Lock Mechanism
- Shock Absorber
- Soft-Feel Grips

Telescopic 9" Soft Grip Handle

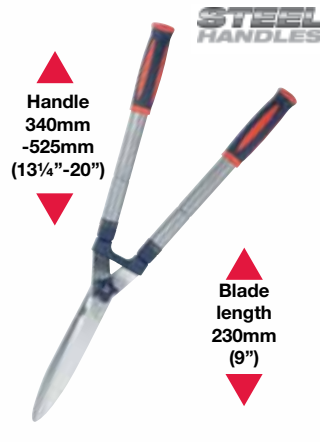

Part No	Type	Blade Length	Pack Qty
SJ-4904RSS	9" Telescopic	230mm	5

- Telescopic Tubular Steel Handles For Maximum Strength
- Blade Notched For Cutting Thicker Stems
- C50 Carbon Steel Blades For Lasting Sharpness
- Polished & Lacquered Blades For Rust Resistance
- Soft-Feel Grips



The super tough 9" Telescopic Hedge Shear is designed to meet some of the most demanding standards, with tubular steel handles for extra strength & durability.



The Standard 9" Soft Grip Shears feature the finest precision cutting and is the obvious choice for gardeners who demand and expect precise, powerful performance

Topiary Shears



Part No	Type	Blade Length	Pack Qty
SJ-4855TS	6.5" Topiary	164mm	5

- High Carbon Steel Blades
- Soft-Feel Handles For Extra Comfort
- Safety Lock Catch

Single-Handed Grass Shears



Part No	Type	Blade Length	Pack Qty
SJ-8130RS	Grass Shears 7"	180mm	5

- Cuts At Any Angle
- Twist To Required Position
- Bi-Material Non-Slip Comfort Grips
- Single Handed Operation
- PTFE Coated Blades For Rust Resistance And Smooth Cutting



Ideal for multiple garden trimming tasks
The rotating body allows cutting at any angle

RAZORSHARP shears



Advance Edging Shears

- Innovative Ergonomic Design
- Ergonomically Designed Long Handles For Comfortable Use
- Reduces Required Arm Movement By 50%
- 8"/200mm PTFE Coated Blades For Rust Resistance
- High Performance Carbon Steel Cutting Edge

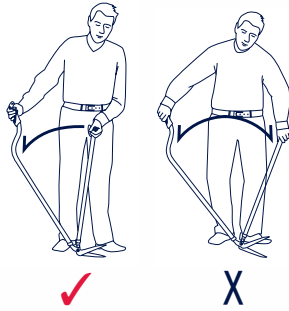
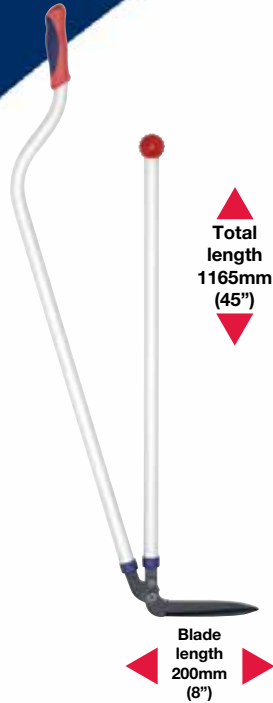

Encourages the user to adopt a more upright stance, resulting in reduced back strain



Part No	Type	Blade Length	Pack Qty
SJ-8250RS	Advance Edging Shear	200mm	5

Advance Multi Shears

- C50 Carbon Steel Blades Rotate 180° So Can Operate As Both Lawn Shears Or Edging Shears
- Adjustable Head Angle - Can Also Operate As Straight, Long Reach Shears
- Extendable Hand Grip
- Adjustable Setting Of Blade Angle & Head Angle Allows User To Achieve Neater, Tidier Cutting And Edge Finishing

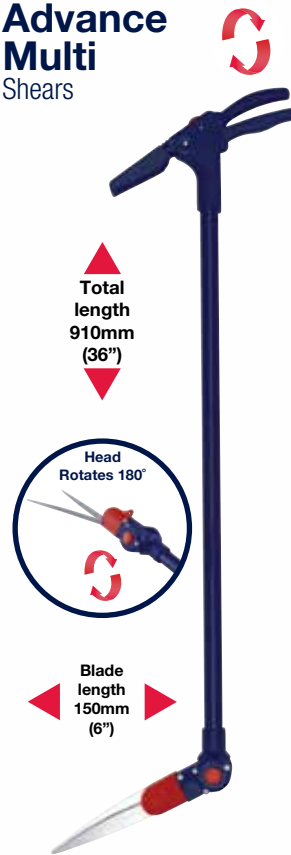

Part No	Type	Blade Length	Pack Qty
SJ-4873MS	Advance Multi Shears	150mm	5

Edging Shears Steel Handles



Part No	Type	Blade Length	Pack Qty
SJ-4900RSS	Edging Shears 9"	230mm	5

- Tubular Steel Handles For Maximum Strength
- Hollow Ground C50 Carbon Steel Blades For Lasting Sharpness
- Soft-Feel Grips
- Polished And Lacquered Blades For Rust Resistance

Edging Shears Soft Grip Handles

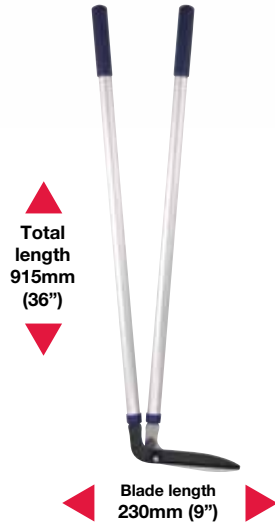

Part No	Type	Blade Length	Pack Qty
SJ-4870RS	Premium Edging Shears	230mm	5

- C50 Carbon Steel Blades, Hardened And Tempered For Durability
- PTFE Coated Blades For Rust Resistance And Smooth Cutting
- Longer Handles To Enable A More Comfortable, Upright Position
- Non-Slip Comfort Grips

Lawn Shears Steel Handles

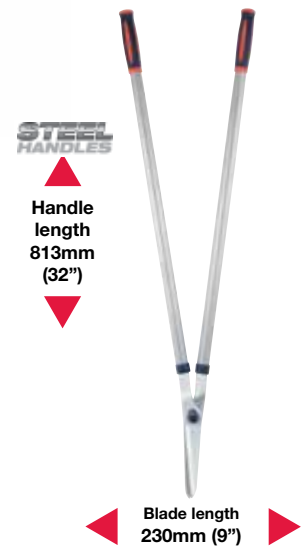

Part No	Type	Blade Length	Pack Qty
SJ-4901RSS	Lawn Shear 9"	230mm	5

- Tubular Steel Handles For Maximum Strength
- Hollow Ground C50 Carbon Steel Blades For Lasting Sharpness
- Soft-Feel Grips
- Polished And Lacquered Blades For Rust Resistance

RAZORSHARP scythettes & fern hooks



Scythette
Little Gaint 305mm



Part No	Type	Blade Length	Pack Qty
SJ-4731SL	Scythette Short Hdle	305mm	5

- Ideal For Cutting Long Grass, Nettles & Removing Weeds And Brush
- Weatherproofed Hardwood Handle
- Hardened Steel Blade

Scythette
Long Handle 305mm



Part No	Type	Blade Length	Pack Qty
SJ-4752SS	Scythette Long Hdle	305mm	5

- Ideal For Cutting Long Grass, Nettles & Removing Weeds And Brush
- Long Tubular Steel Handle With Soft Grip
- Hardened Steel Blade

Scythette
Spare Blade 305mm



Part No	Type	Blade Length	Pack Qty
SJ-4732SY	Scythette Spare Blade	305mm	5

- Ideal For Cutting Long Grass, Nettles & Removing Weeds And Brush
- Spare Blade

Fern Hook
Hardwood Handle



Part No	Type	Blade Length	Pack Qty
SJ-4655BM	Fern Hook Long Hdle	380mm	5

- Ideal For Thinning, Trimming And Cleaning Brush And Thickets
- Epoxy Coated Head For Resistance To Rust
- Solid Forged Socket
- Weatherproofed Hickory Handle



Cane Knife
Timber Handle



Part No	Type	Blade Length	Pack Qty
SJ-2100615	Cane Knife	360mm	24

- Made From Sheffield Steel
- Edge Sharpened & Tempered
- 2.5mm Thick Roll Forged Blade
- Hardened For Strength And Reliability
- Weatherproofed Hardwood Handle

Fern Hook
Single Edge Head



Part No	Type	Blade Length	Pack Qty
SJ-4680AU	Fern Hook - Head Only	343mm	25

- Ideal For Removing Blackberrys, Vines, Thickets And Heavy Undergrowth
- Curved Factory Sharpened Blade
- Fully Forged Epoxy Coated Head For Rust Resistance
- Head Only

RAZORSHARP predator bow saws

Predator Bow Saw T-Frame 21"



Part No	Type	Pack Qty
SJ-B9821BOWSAWTF	Bow Saw 21" T-Frame	5

- Holds 21" Peg Tooth & Raker Tooth Blades
- Tampered Frame Allows For Angled Cuts In Tight Areas Eg. Roofing & Dense Foliage
- Adjustable Blade Tensioner
- Soft Feel Ergonomic Handle
- Tubular Steel Frame
- Built-In Hand Guard For Extra Protection
- Simplistic Design Allows For Quick And Easy Blade Changes
- Saws Sold Fitted With Peg Tooth Blades (Raker Blades Are Also Available, Sold Separately).

Predator Bow saw 21"



Part No	Type	Pack Qty
SJ-B9821BOWSAW	Bow Saw 21"	5

- Holds 21" Blades Peg Tooth & Raker Tooth
- Adjustable Blade Tensioner
- Soft Feel Ergonomic Handle
- Tubular Steel Frame
- Built-In Hand Guard For Extra Protection
- Simplistic Design Allows For Quick And Easy Blade Changes
- Saws Sold Fitted With Peg Tooth Blades (Raker Blades Are Also Available, Sold Separately).

Predator Bowsaw 24"



Part No	Type	Pack Qty
SJ-B9824BOWSAW	Bow Saw 24"	5

- Holds 24" Blades Peg Tooth & Raker Tooth
- Adjustable Blade Tensioner
- Soft Feel Ergonomic Handle
- Tubular Steel Frame
- Built-In Hand Guard For Extra Protection
- Simplistic Design Allows For Quick And Easy Blade Changes
- Saws Sold Fitted With Peg Tooth Blades (Raker Blades Are Also Available, Sold Separately).

Predator Bowsaw 30"



Part No	Type	Pack Qty
SJ-B9830BOWSAW	Bow Saw 30"	5

- Holds 30" Blades Peg Tooth & Raker Tooth
- Adjustable Blade Tensioner
- Soft Feel Ergonomic Handle
- Tubular Steel Frame
- Built-In Hand Guard For Extra Protection
- Simplistic Design Allows For Quick And Easy Blade Changes
- Saws Sold Fitted With Peg Tooth Blades (Raker Blades Are Also Available, Sold Separately).

Peg & Raker Tooth Blades 21", 24", 30"



Part No	Type	Size	Pack Qty
SJ-B9821DRYBLADE	Peg	21"	10
SJ-B9824DRYBLADE	Peg	24"	10
SJ-B9830DRYBLADE	Peg	30"	10
SJ-B9821WETBLADE	Raker	21"	10
SJ-B9824WETBLADE	Raker	24"	10
SJ-B9830WETBLADE	Raker	30"	10

- Hardpoint Carbon Steel Blades
- Available In 21" (530MM) 4TPI (Teeth Per Inch) 24" (610MM) 4TPI (Teeth Per Inch) 30" (760MM) 4TPI (Teeth Per Inch)
- Made In Portugal



The Spear & Jackson Predator Bow Saw range offers two types of blades
Peg Tooth (Dry) & Raker Tooth (Wet).

PEG TOOTH BLADE (DRY)

The peg toothing blade is for mature and dry wood. Every third gullet is extended for high chip removal and is made uniquely for fast and efficient cutting of mature and dry wood.

RAKER TOOTH BLADE (WET)

The raker toothing blade is for live and green wood. Every fifth tooth is raker and unset which functions like a chisel to remove the chips out of the green wood.



Predator Bow Saw Merchandiser

- Holds 12 Predator Bow Saws
- Holds 48 Predator Bow Saw Blades
- Provides Blade Selection Information To Help Customers With Their Product Choice
- Made From Powder Coated Carbon Steel
- Designed To Fit Most Display Types

RAZORSHARP - other cutting pruning saws & bow saws

Pruning Saw

Small Folding



Part No	Type	Blade Length	Pack Qty
SJ-4960RSA	Folding Pruning Saw	7"	5

- 7" (178mm) Carbon Steel Blade
- Hollow Ground Blade For Enhanced Cutting Performance
- Ultra Sharp 7TPI Precision Ground Teeth
- Folds For Storage And Blade Protection
- Blade Locks In Open And Closed Position

Pruning Saw

Large Folding



Part No	Type	Blade Length	Pack Qty
SJ-4948PS	Folding Pruning Saw	12"	5

- 12" (305mm) SK5 Carbon Steel Blade For Lasting Sharpness
- Ultra Sharp 7TPI Precision Ground Teeth
- Chrome Plated Blade For Rust Resistance
- Blade Locks In Open And Closed Position

Pruning Saw

Plastic Handle



Part No	Type	Blade Length	Pack Qty
SJ-66PS	Pruning Saw - Plastic	14"	5

- 14" (350mm) Carbon Steel Blade
- Cuts Branches Up To 90mm
- Strong Plastic Handle

Pruning Saw

Timber Handle



Part No	Type	Blade Length	Pack Qty
SJ-P9325	Pruning Saw - Timber	13"	6

- 13" (325mm) Carbon Steel Blade
- Laquered Hardwood Handle
- Cuts Branches Up To 90mm

Bowsaw

21"



Part No	Type	Blade Length	Pack Qty
SJ-3621K	Bow Saw 21"	21"	5

- Hardpoint Blade Which Stays Sharp Up To 5 Times Longer Than Untreated Blades
- Teeth Designed For Fast And Free Cutting On Forward And Backward Strokes
- Lever Tension Device For Simple Blade Changing
- 3TPI

Spare Blade: **SJ-3921W**

Bowsaw

24"



Part No	Type	Blade Length	Pack Qty
SJ-3624Z	Bow Saw 24"	24"	5

- Hardpoint Blade Which Stays Sharp Up To 5 Times Longer Than Untreated Blades
- Teeth Designed For Fast And Free Cutting On Forward And Backward Strokes
- Lever Tension Device For Simple Blade Changing
- 3TPI

Spare Blade: **SJ-3924C**

Telescopic Tree

Pruner

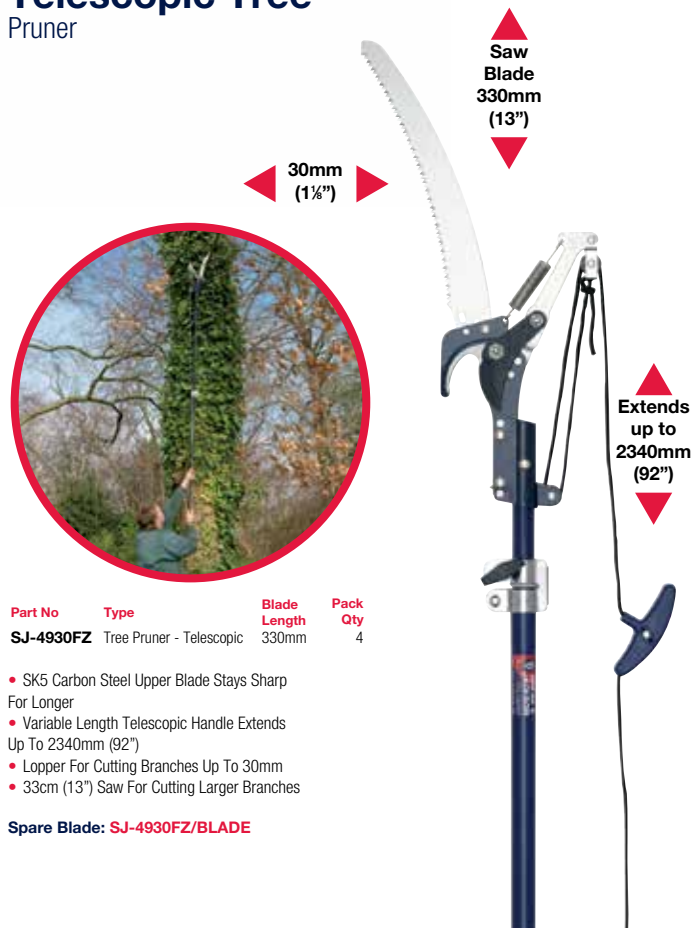

Part No	Type	Blade Length	Pack Qty
SJ-4930FZ	Tree Pruner - Telescopic	330mm	4

- SK5 Carbon Steel Upper Blade Stays Sharp For Longer
- Variable Length Telescopic Handle Extends Up To 2340mm (92")
- Lopper For Cutting Branches Up To 30mm
- 33cm (13") Saw For Cutting Larger Branches

Spare Blade: **SJ-4930FZ/BLADE**

RAZORSHARP - other cutting timber & fibreglass axes

Axe 1.5lb Timber Handle



Handle length
380mm
(15")

Part No	Type	Handle Length	Pack Qty
SJ-3715AB	Axe 1.5lb Timber Hdle	380mm	4

- Drop Forged Carbon Steel Head
- Hardened and Tempered for Durability
- Dual Cylindrical Wedges
- High Quality Hickory Shafts
- 1.5lb (680g)
- FSC Certified Handle

Axe 2.5lb Timber Handle



Handle length
485mm
(19")

Part No	Type	Handle Length	Pack Qty
SJ-3725CD	Axe 2.5lb Timber Hdle	485mm	2

- Drop Forged Carbon Steel Head
- Hardened and Tempered for Durability
- Dual Cylindrical Wedges
- High Quality Hickory Shafts
- 2.5lb (1.1kg)
- FSC Certified Handle

Axe 4.5lb Timber Handle



Handle length
845mm
(33")

Part No	Type	Handle Length	Pack Qty
SJ-3745EF	Axe 4.5lb Timber Hdle	845mm	6

- Drop Forged Carbon Steel Head
- Hardened and Tempered for Durability
- Dual Cylindrical Wedges
- High Quality Hickory Shafts
- 4.5lb (2kg)
- FSC Certified Handle



Each Axe

- Has A Drop Forged Carbon Steel Head, Hardened & Tempered For Durability
- Has A Quality Hickory Shaft For Strength
- Has A Blade Guard For Added Safety When Not In Use

Axe 1.5lb Fibreglass Handle



Handle length
380mm
(15")

Part No	Type	Handle Length	Pack Qty
SJ-AFG15	Axe 1.5lb F/G Hdle	380mm	4

- Drop Forged Carbon Steel Head
- Hardened and Tempered for Durability
- Quality Fibreglass Shaft
- Non Slip Soft Grip
- 1.5lb (680g)

Axe 2.5lb Fibreglass Handle



Handle length
485mm
(19")

Part No	Type	Handle Length	Pack Qty
SJ-AFG25	Axe 2.5lb F/G Hdle	485mm	4

- Drop Forged Carbon Steel Head
- Hardened and Tempered for Durability
- Quality Fibreglass Shaft
- Non Slip Soft Grip
- 2.5lb (1.1kg)

Axe 4.5lb Fibreglass Handle



Handle length
845mm
(33")

Part No	Type	Handle Length	Pack Qty
SJ-AFG45	Axe 4.5lb F/G Hdle	845mm	6

- Drop Forged Carbon Steel Head
- Hardened and Tempered for Durability
- Quality Fibreglass Shaft
- Non Slip Soft Grip
- 4.5lb (2kg)



RAZORSHARP - other cutting blocksplitters & hatchets

Blocksplitter 6lb Timber Handle



▲
Handle
length
810mm
(32")
▼

Part No	Type	Handle Length	Pack Qty
SJ-3750BS	Blocksplitter 6lb	810mm	2

- Drop Forged Carbon Steel Head
- Hardened and Tempered for Durability
- High Quality Hickory Shaft
- 6.0lb (2.7kg)
- FSC Certified Handle

Blocksplitter 6lb Fibreglass Handle



▲
Handle
length
845mm
(33")
▼

Part No	Type	Handle Length	Pack Qty
SJ-BFG60	Blocksplitter 6lb	845mm	2

- Drop Forged Carbon Steel Head
- Hardened and Tempered for Durability
- Quality Fibreglass Shaft
- Non Slip Grip
- 6.0lb (2.7kg)



hatchets

Camping Axe Steel Handle



Part No	Type	Handle Length	Pack Qty
EG-7216	Camping Axe 570g	270mm	6

- Non Slip Comfort Grip
- Tubular Steel Handle
- Carbon Steel Head
- 1.2lb (570g)

Felling Hatchet Timber Handle



Part No	Type	Handle Length	Pack Qty
EG-9601A	Felling Hatchet	300mm	12

- Hardwood Timber Handle
- Carbon Steel Head
- Weight 1.2lb (570g)



HANDLES

brooms, rakes, files & sledge hammers,

Rake Handle Timber Shaft



Part No	Type	Handle Length	Pack Qty
AH-U111	Rake Handle - Timber	1500 x 25mm	10
AH-U112	Rake Handle - Timber	1800 x 25mm	10
AH-U115	Rake Handle - Timber	1800 x 29mm	10

- Designed to Fit Most Rake Heads
- FSC Certified Timber Handle
- Tapered Timber Shaft

Broom Handle Timber Shaft



Part No	Type	Handle Length	Pack Qty
AH-U149	Broom Handle - Timber	1350 x 22mm	10
AH-U154	Broom Handle - Timber	1350 x 25mm	10
AH-U155	Broom Handle - Timber	1500 x 25mm	10
AH-U156	Broom Handle - Timber	1650 x 25mm	10
AH-U157	Broom Handle - Timber	1800 x 25mm	10
AH-U159	Broom Handle - Timber	1800 x 29mm	10

- Designed to Fit Most Broom Heads
- FSC Certified Timber Handle
- Tapered Timber Shaft

Broom Handle White Timber Shaft



Part No	Type	Handle Length	Pack Qty
AH-U149-WHITE	Broom Handle	1350 x 22mm	10

- Designed to Fit Most Broom Heads
- FSC Certified Timber Handle
- White Tapered Timber Shaft

File Handle Timber



Part No	Type	Handle Length	Pack Qty
AH-U286	File Handle	75mm	50
AH-U287	File Handle	100mm	50
AH-U288	File Handle	125mm	50
AH-U289	File Handle	150mm	50

- Designed to Fit Most Files
- FSC Certified Timber Handle
- Shaped Timber Handle



Spear & Jackson Handles Are Made From FSC Certified Timber Which Supports the Responsible Management of Forests Worldwide

SPEAR & JACKSON
COLOURS
COLLECTION



A new range of garden hand tools, secateurs, shears, loppers and scoops available in three eye-catching colours

Secateurs

Bypass 7"



Part No	Type	Total Length	Pack Qty
SJ-CSB	Secateurs Blue	7"	5
SJ-CSG	Secateurs Green	7"	5
SJ-CSP	Secateurs Pink	7"	5

- SK-5 High Quality Carbon Steel
- 6" Soft Grip Handles
- 15mm Maximum Cutting Capacity
- Overall Length 7" (180mm)

Loppers

Bypass



Part No	Type	Total Cutting Cap.	Pack Qty
SJ-56551B	Loppers Blue	25mm	5
SJ-56551G	Loppers Green	25mm	5
SJ-56551P	Loppers Pink	25mm	5

- C50 Carbon Steel Blade
- Geared Cutting Action
- Soft Feel Grip For Increased Comfort
- 25mm Maximum Cutting Capacity
- Overall Length 18" (460mm)

Shears

Wavy Edged 8"

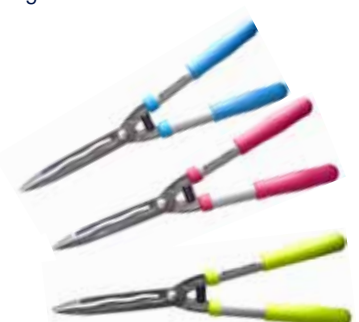

Part No	Type	Total Cutting Cap.	Pack Qty
SJ-55509B	Shears Blue	25mm	5
SJ-55509G	Shears Green	25mm	5
SJ-55509P	Shears Pink	25mm	5

- C50 Carbon Steel 8" (200mm) Wavy Edged Blades
- Blades Heat Treated for Strength & Durability
- Lightweight But Strong Tubular Steel Handles
- Shock Absorbers For Comfortable Use
- Overall Length 20" (520mm)

Hand Trowel 6"

PVC Handle



Part No	Type	Head Size	Pack Qty
SJ-SDT/10B	Hand Trowel Blue	6"	6
SJ-SDT/10G	Hand Trowel Green	6"	6
SJ-SDT/10P	Hand Trowel Pink	6"	6

- Ideal for planting small plants, cuttings and seedlings
- Epoxy Coated Carbon Steel Head
- PVC Handle
- Lightweight Design

Transplanter

PVC Handle



Part No	Type	Head Size	Pack Qty
SJ-SDT/20B	Transplanter Blue	6"	6
SJ-SDT/20G	Transplanter Green	6"	6
SJ-SDT/20P	Transplanter Pink	6"	6

- Ideal for planting small plants, cuttings and seedlings
- Epoxy Coated Carbon Steel Head
- PVC Handle
- Lightweight Design

Weeder

PVC Handle



Part No	Type	Head Size	Pack Qty
SJ-SDT/30B	Weeder Blue	6"	6
SJ-SDT/30G	Weeder Green	6"	6
SJ-SDT/30P	Weeder Pink	6"	6

- Ideal for removing weeds & small plants from lawns & garden beds
- Epoxy Coated Carbon Steel Head
- PVC Handle
- Lightweight Design

3 Prong Cultivator

PVC Handle



Part No	Type	Head Size	Pack Qty
SJ-SDT/40B	Cultivator Blue	6"	6
SJ-SDT/40G	Cultivator Green	6"	6
SJ-SDT/40P	Cultivator Pink	6"	6

- Ideal for breaking up light soils and weeding
- Epoxy Coated Carbon Steel Head
- PVC Handle
- Lightweight Design

Twist Fork

PVC Handle



Part No	Type	Head Size	Pack Qty
SJ-SDT/50B	Twist Fork Blue	6"	6
SJ-SDT/50G	Twist Fork Green	6"	6
SJ-SDT/50P	Twist Fork Pink	6"	6

- Ideal for cultivating light soils
- Epoxy Coated Carbon Steel Head
- PVC Handle
- Lightweight Design

Scoops

Plastic



Part No	Type	Total Size	Pack Qty
SJ-PSMP	Plastic Scoop	250mm	18

- Light and Strong Polypropylene Scoop
- Hanging Hole For Storage
- Overall Length 10" (250mm) Per Scoop
- Sold as Display Box

Colours Secateurs Display Box

- SK-5 High Quality Carbon Steel
- 6" Soft Grip Handles
- 15mm Maximum Cutting Capacity
- Overall Length 7" (180mm)

Merchandiser Holds 15 Coloured Secateurs

- 5x Blue Secateurs
- 5x Pink Secateurs
- 5x Green Secateurs

SJ-CSMP



Plastic Scoop Display Box

- Light and Strong Polypropylene Scoop
- Hanging Hole For Storage
- Overall Length 10" (250mm) Per Scoop

Merchandiser Holds 18 Coloured Scoops

- 6x Blue Scoops
- 6x Pink Scoops
- 6x Green Scoops

SJ-PSMP



The Spear & Jackson Colours Merchandiser is the perfect way to present the entire Colours Range.

Merchandiser Quantities

- 5 x Blue / Pink / Green Secateurs
- 5 x Blue / Pink / Green Loppers
- 5 x Blue / Pink / Green Shears
- 18 x Blue / Pink / Green Scoops
- 6 x Blue / Pink / Green Trowels
- 6 x Blue / Pink / Green Transplanters
- 6 x Blue / Pink / Green Weeders
- 6 x Blue / Pink / Green Cultivators
- 6 x Blue / Pink / Green Twist Forks

* stock sold separately

SPEAR & JACKSON
COLOURS
COLLECTION



**Brighten up your Garden
with the NEW Spear &
Jackson Colours Range**

Contact us today!

CONTACT US:

Ph: 1300 731 818

Fax: 1300 735 858

Email: sales@spear-and-jackson.com.au

Web: www.spearandjackson.com.au





SPEAR & JACKSON

HAND TOOLS

2015

HAND SAWS

HAMMERS

GENERAL HAND TOOLS

MASONRY TOOLS

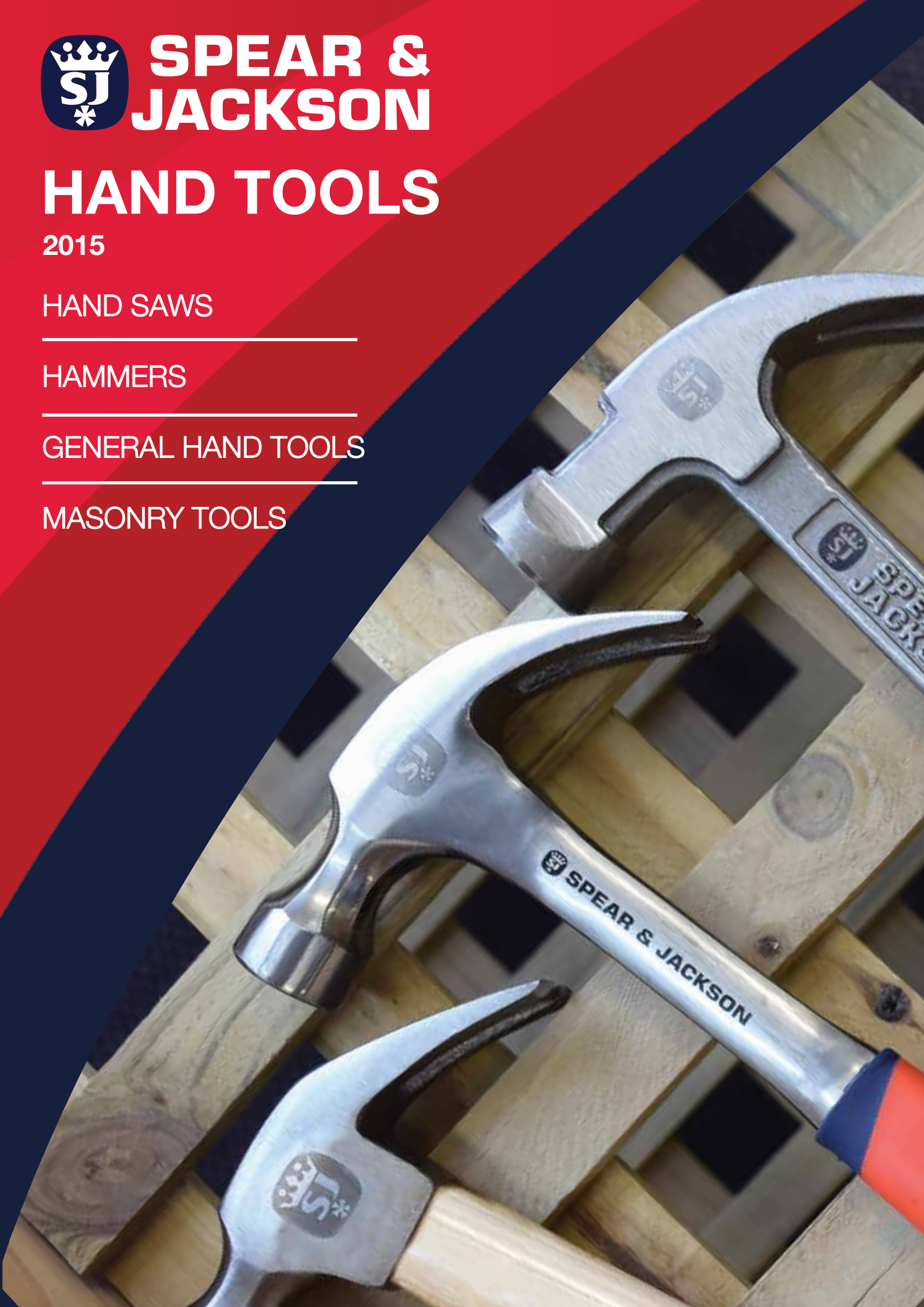

HAND SAWS

PROFESSIONAL WOODSAWS

SPEAR & JACKSON began making saws well over 200 years ago. The wealth of experience gained over this period of time is just one of the many reasons why SPEAR & JACKSON have a unique reputation.

The SPEAR & JACKSON PREDATOR™ Series is a range of handpoint saws especially created to meet the most demanding professional. The range includes saws for four specialist applications First Fix, Second Fix, Laminate, and UPVC.

The range also includes our multi-purpose Universal tooth saw, our Triplefast triple ground tooth saw and our Predator X fleam tooth saw. All saws are heat treated using the very latest technology to ensure outstanding durability and performance. PREDATOR™ are quite simply the best saws you can buy!



WOODWORKING TOOLS

professional woodsaws

PREDATOR™

Universal



PREDATOR™

Part No	Description	Size	Finish	Pack Qty
SJ-B9822	Universal	22"/550mm x 8pts	Medium	10

- A General Purpose Saw for Use Along and Across the Grain
- Fast Cut - Rapid, Clean Cutting Action
- Rigid Blade Minimises 'Whip' and Vibration
- Ideal for Timber, Hardwood, Chipboard and MDF
- Comfortable Handle - Suregrip® Soft-Feel Ergonomic Grip and Finger Guide for Accuracy, also Incorporating a Useful 45/90° Angle Guide

First Fix



PREDATOR™

Part No	Description	Size	Finish	Pack Qty
SJ-B98FF	First Fix	22"/550mm x 7pts	Rough	10

- A Fast Cutting Saw for Use Along and Across the Grain
- Fast Cut - Rapid, Clean Cutting Action
- Rigid Blade Minimises 'Whip' and Vibration
- Use With All Rough Sawn Timber
- Comfortable Handle - Suregrip® Soft-Feel Ergonomic Grip and Finger Guide for Accuracy, also Incorporating a Useful 45/90° Angle Guide

Triplefast



PREDATOR™

Part No	Description	Size	Finish	Pack Qty
SJ-B98TRIPLE	Triplefast	22"/550mm x 10pts	Medium	10

- A Fine Cutting Saw for Cutting Along and Across the Grain
- Triple Ground Tooth Configuration
- Fast Cut - Rapid, Clean Cutting Action
- Rigid Blade Minimises 'Whip' and Vibration
- Ideal For a Smooth Finish On Soft Woods
- Comfortable Handle - Suregrip® Soft-Feel Ergonomic Grip and Finger Guide for Accuracy, Also Incorporating a Useful 45/90° Angle Guide

UPVC



PREDATOR™

Part No	Description	Size	Finish	Pack Qty
SJ-B98UPVC	UPVC	20"/500mm x 14pts	Fine	10

- A Hardpoint Saw for Cutting UPVC and Hard Plastics
- Fast Cut - Rapid, Clean Cutting Action
- Rigid Blade Minimises 'Whip' and Vibration
- Ideal for Cutting Sills, Trims and Plastic Pipes
- Comfortable Handle - Suregrip® Soft-Feel Ergonomic Grip and Finger Guide for Accuracy, Also Incorporating a Useful 45/90° Angle Guide

Laminate



PREDATOR™

Part No	Description	Size	Finish	Pack Qty
SJ-B98LAMINATE	Laminate	20"/500mm x 14pts	Extra Fine	10

- A Hardpoint Saw Delivering a Fine Cut
- Fast Cut - Rapid, Clean Cutting Action
- Rigid Blade Minimises 'Whip' and Vibration
- For Use On Laminate Flooring, Formica and Beading
- Comfortable Handle - Suregrip® Soft-Feel Ergonomic Grip and Finger Guide for Accuracy, Also Incorporating a Useful 45/90° Angle Guide

Predator X



PREDATOR™

Part No	Description	Size	Finish	Pack Qty
SJ-B98X	Fleam Tooth	22"/550mm x 8pts	Medium	10

- Fleam Teeth for the Fastest Cut Along and Across The Grain On Both the Forward and Reverse Stroke
- Fast Cut - Rapid, Clean Cutting Action
- Rigid Blade Minimises 'Whip' and Vibration
- Ideal for Use On Timber, Hardwood, Chipboard and MDF
- Comfortable Handle - Suregrip® Soft-Feel Ergonomic Grip and Finger Guide for Accuracy, Also Incorporating a Useful 45/90° Angle Guide

WOODWORKING TOOLS

professional woodsaws

Quick Cut



PREDATOR™

Part No	Description	Size	Finish	Pack Qty
SJ-B98QC	Predator Quick Cut	20"/500mm x 8pts	Medium	60

- For General Use Cutting Along and Across the Grain
- Cross Ground Teeth Cut In Both Directions
- ABS Handle With Built In Finger Guide
- Rigid 0.91Mm Blade Minimises Whip and Vibration
- Heat Treated Teeth Maximises Blade Life
- Handle Includes 90° and 45° Angle Guide

Toolbox Saw



PREDATOR™

Part No	Description	Size	Finish	Pack Qty
SJ-B9814	Predator Toolbox	14"/350mm x 14pts	Fine	10

- A Fine Cut for Smooth Cutting With Push/Pull Action
- Rigid Blade Minimises "Whip" and Vibration
- Ideal for Cutting Moulding, Dowelling, Architraves and Skirting
- Comfortable Handle - Suregrip® Soft-Feel Ergonomic Grip and Finger Guide for Accuracy
- Handle Includes 90° And 45° Angle Guide

Tenon Saws



PREDATOR™

Part No	Description	Size	Finish	Pack Qty
SJ-B9812	Predator Tenon	12"/300mm x 15pts	Fine	10

- A Fine Cut for a Smooth, Clean Cutting Action
- Solid Steel Back for Maximum Rigidity and Accuracy
- Ideal for Cutting Moulding, Dowelling, Architraves and Skirting
- Comfortable Handle - Suregrip® Soft-Feel Ergonomic Grip and Finger Guide for Accuracy.
- Handle Includes 90° And 45° Angle Guide

** Now Available in 60 Saw Merchandiser

traditional woodsaws

Skew Back



Part No	Description	Size	Finish	Pack Qty
SJ-9500R	Traditional Skew Back	22"/550mm x 10pts	Medium	10
SJ-9525X	Traditional Skew Back	26"/650mm x 7pts	Rough	10

- Universal Teeth for General Use - Cuts Along and Across the Grain
- Precision Cross Ground Teeth for Extra Sharpness
- Teeth Can Be Resharpended
- Skew Back for Balance and Reduced Friction
- Cuts Timber Chipboard, Plywood and Other Wood Based Materials
- Comfortable Wooden Handle Securely Fixed By Rivets
- High Carbon Steel Blade

Brass Back Tenon



Part No	Description	Size	Finish	Pack Qty
SJ-9540B	Traditional Brass Back	10"/250mm x 15pts	Fine	10
SJ-9550B	Traditional Brass Back	12"/300mm x 15pts	Fine	10

- Universal Teeth for General Use - Cuts Along and Across the Grain
- Brass Back for Maximum Rigidity and Accuracy
- Teeth Can Be Resharpended
- Used for Joint Cutting and Sawing Small Pieces Of Wood and Wood Based Materials
- Comfortable Wooden Handle Securely Fixed By Rivets
- High Carbon Steel Blade
- Precision Ground Teeth

Professional Tenon



SPECIAL ORDER ONLY

Part No	Description	Size	Finish	Pack Qty
SJ-5410Y	Professional Tenon	10"/250mm x 13pts	Fine	10
SJ-5412K	Professional Tenon	12"/300mm x 13pts	Fine	10

- Universal Teeth for General Use - Cuts Along and Across the Grain
- Precision Cross Ground Teeth for Extra Sharpness
- Teeth Can Be Resharpended
- Solid Brass Back for Maximum Rigidity and Accuracy
- Used for Joint Cutting and Sawing Small Pieces Of Wood
- Comfortable Wooden Handle Secured With Solid Brass Screws

HAMMERS

All SPEAR & JACKSON hammers are made from first class materials and manufactured to the highest product specifications, thus ensuring maximum strength and reliability. Forged heads are expertly heat treated and finished, then fixed to hickory or fibreglass shafted handles. All Steel and Anti Vibration hammers are forged with the head and shaft as a unit. This ensures reliability and balance, plus ensuring superior performance for the professional and occasional user alike.



HAND TOOLS

hammers

Claw Hammer Wooden Handle



Part No	Description	Size	Pack Qty
SJ-CH16W	Claw Hammer Wooden	16 Oz/450g	6
SJ-CH20W	Claw Hammer Wooden	20 Oz/570g	6
SJ-CH24W	Claw Hammer Wooden	24 Oz/680g	4

- Heat Treated Fully Polished Head
- Dual Cylindrical Wedges for Added Safety
- Hickory Handle

Claw Hammer Fibreglass Handle



Part No	Description	Size	Pack Qty
SJ-CH16FG	Claw Hammer Fibreglass	16 Oz/450g	6
SJ-CH20FG	Claw Hammer Fibreglass	20 Oz/570g	6
SJ-CH24FG	Claw Hammer Fibreglass	24 Oz/680g	6

- Heat Treated Fully Polished Head
- Tough Fibreglass Handle
- Dual Material Soft Grip Handle

Claw Hammer All Steel Handle



Part No	Description	Size	Pack Qty
SJ-CH20AS	Claw Hammer All Steel	20 Oz/570g	6
SJ-CH24AS	Claw Hammer All Steel	24 Oz/680g	6

- Heat Treated Fully Polished Head
- Forged One Piece Head and Handle
- Grip Mechanically Pinned To Shaft
- Dual Material Soft Grip Handle

Claw Hammer Anti Vibration



Part No	Description	Size	Pack Qty
SJ-CH20FA	Claw Hammer Anti Vibe	20 Oz/570g	6
SJ-CH24FA	Claw Hammer Anti Vibe	24 Oz/680g	6

- Anti Vibration I Beam Design
- Forged One Piece Head and Handle
- Magnetic Nail Start
- Oversized Strike Area
- Grip Mechanically Pinned To Shaft
- Dual Material Soft Grip Handle

Brick Hammer Fibreglass Handle



Part No	Description	Size	Pack Qty
SJ-BRH24FG	Brick Hammer Fibreglass	24 Oz/680g	6

- Tough Fibreglass Handle
- Fully Polished Head
- Dual Material Soft Grip Handle

Brick Hammer All Steel Handle



Part No	Description	Size	Pack Qty
SJ-BRH24AS	Brick Hammer All Steel	24 Oz/680g	6

- Forged One Piece Head and Handle
- Grip Mechanically Pinned To Shaft
- Dual Material Soft Grip Handle
- Fully Polished Head

HAND TOOLS

hammers

Ball Pein Hammer

Wooden Handle



Part No	Description	Size	Pack Qty
SJ-BPH8	Ball Pein Hammer Wooden	8 Oz/226g	6
SJ-BPH12	Ball Pein Hammer Wooden	12 Oz/340g	6
SJ-BPH16	Ball Pein Hammer Wooden	16 Oz/450g	5
SJ-BPH24	Ball Pein Hammer Wooden	24 Oz/680g	4
SJ-BPH32	Ball Pein Hammer Wooden	32 Oz/900g	4

- Ideal For Shaping Metal & Light Engineering Work
- Premium Hickory Handle
- Heat Treated Fully Polished Head
- Dual Wedges for Added Safety

Ball Pein Hammer

Fibreglass Handle



Part No	Description	Size	Pack Qty
SJ-BPH16FG	Ball Pein Hammer Fibreglass	16 Oz/450g	6
SJ-BPH24FG	Ball Pein Hammer Fibreglass	24 Oz/680g	6
SJ-BPH32FG	Ball Pein Hammer Fibreglass	32 Oz/900g	6

- Tough Fibreglass Handle
- Heat Treated Fully Polished Head
- Dual Material Soft Grip Handle

Cross Pein Hammer

Wooden Handle



Part No	Description	Size	Pack Qty
SJ-CPH8	Cross Pein Hammer Wooden	8 Oz/226g	6
SJ-CPH10	Cross Pein Hammer Wooden	10 Oz/280g	6
SJ-CPH12	Cross Pein Hammer Wooden	12 Oz/340g	6
SJ-CPH14	Cross Pein Hammer Wooden	14 Oz/396g	6

- Ideal For Light Joinery and Cabinet Work
- Premium Hickory Handle
- Heat Treated Fully Polished Head
- Dual Wedges for Added Safety

Club Hammer

Wooden Handle



Part No	Description	Size	Pack Qty
SJ-CH3W	Club Hammer Wooden	3lb/1.3Kg	4
SJ-CH4W	Club Hammer Wooden	4lb/1.8Kg	4

- Hickory Handle
- Heat Treated Head
- Cylindrical Wedges for Added Safety

Club Hammer

Fibreglass Handle



Part No	Description	Size	Pack Qty
SJ-FGCH3	Club Hammer Fibreglass	3lb/1.3Kg	4
SJ-FGCH4	Club Hammer Fibreglass	4lb/1.8Kg	4

- Tough Fibreglass Handle
- Heat Treated Head
- Dual Material Soft Grip Handle

Club Hammer

All Steel Handle



Part No	Description	Size	Pack Qty
SJ-CH25AS	Club Hammer All Steel	2.5lb/1.1Kg	4
SJ-CH4AS	Club Hammer All Steel	4lb/1.8Kg	4

- One Piece Head and Shaft
- Heat Treated Head
- Dual Material Soft Grip Handle

HAND TOOLS

hammers

Sledge Hammer

Wooden Handle



Part No	Description	Size	Pack Qty
SJ-4LBWH	Sledge Hammer Wooden	4lb/1.8Kg	2
SJ-7LBWH	Sledge Hammer Wooden	7lb/3.2Kg	4
SJ-10LBWH	Sledge Hammer Wooden	10lb/4.5Kg	2
SJ-14LBWH	Sledge Hammer Wooden	14lb/6.4Kg	2

- Premium Hickory Handle
- Hardened and Tempered Head
- Drop Forged Head
- Cylindrical Wedges for Added Safety
- FSC Timber Handle

Sledge Hammer

Fibreglass Handle



Part No	Description	Size	Pack Qty
SJ-SHFP4	Sledge Hammer Fibreglass	4lb/1.8Kg	8
SJ-SHFP7	Sledge Hammer Fibreglass	7lb/3.2Kg	4
SJ-SHFP10	Sledge Hammer Fibreglass	10lb/4.5Kg	2
SJ-SHFP14	Sledge Hammer Fibreglass	14lb/6.4Kg	2

- Head Mechanically Pinned and Chemically Fixed
- Hardened and Tempered Head
- Drop Forged Head
- Overstrike Guard On Sizes 7-14Lb
- Tough Fibreglass Shaft
- Dual Material Soft Grip Handle

Carpenters Mallet

Wooden



Part No	Description	Size	Pack Qty
SJ-CM400	Capenters Mallet	400g	6

- Ideal for Use With Wood Chisels and Shaping Tools
- Made Entirely From Premium Beechwood
- Sculptured All Wood Handle

Rubber Mallet

Wooden Handle



Part No	Description	Size	Pack Qty
EG-12100/16	Rubber Mallet Wooden	16 Oz/450g	6
EG-12100/24	Rubber Mallet Wooden	24 Oz/680g	6
EG-12100/32	Rubber Mallet Wooden	32 Oz/900g	5

- Ideal for Construction, Automotive and General Use
- Laquered Hardwood Handle
- Durable Black Rubber Head

Rubber Mallet

Fibreglass Handle



Part No	Description	Size	Pack Qty
SJ-RM16FG	Rubber Mallet Fibreglass	16 Oz/450g	6
SJ-RM24FG	Rubber Mallet Fibreglass	24 Oz/680g	6
SJ-RM32FG	Rubber Mallet Fibreglass	32 Oz/900g	6

- Ideal for Construction, Automotive and General Use
- Tough Fibreglass Handle
- Durable Black Rubber Head
- Dual Material Soft Grip Handle

White Rubber Mallet

Fibreglass Handle



Part No	Description	Size	Pack Qty
SJ-WRM16FG	White Rubber Mallet Fibreglass	16 Oz/450g	6
SJ-WRM24FG	White Rubber Mallet Fibreglass	24 Oz/680g	6
SJ-WRM32FG	White Rubber Mallet Fibreglass	32 Oz/900g	6

- Ideal for Tiling, Paving and Any Non Marking Application
- Tough Fibreglass Handle
- Durable White Rubber Head
- Dual Material Soft Grip Handle

HUCKSON industrial hammers



Deadblow Hammers

Soft Face Hammer 25mm

Soft Face Hammer 38mm



Non Rebound Head Focuses the Force of the Blow to Minimise Surface Damage



**Nylon Tips = Hard
Poly Tips = Soft**



Includes 3rd Tip

**Nylon Tips = Hard
Poly Tips = Soft**

Part No	Description	Size	Pack Qty
HU-777	Deadblow Hammer 40mm	700g	5
HU-778	Deadblow Hammer 60mm	1600g	5

- Hammer Head Filled with Shot
- Cast One Piece Head and Body
- Replaceable Tips
- Made in Australia

Part No	Description	Size	Pack Qty
HU-701/1N	Soft Face Hammer - Nylon Tips	250g	5
HU-701/1P	Soft Face Hammer - Poly Tips	250g	5
HU-701/1NP	Soft Face Hammer -Nylon & Poly Tips	250g	5

- Used for Assembly and Repair Operations to Minimise the Damage to Soft Surfaces
- Cast One Piece Head and Body
- Replaceable Tips
- Made in Australia

Part No	Description	Size	Pack Qty
HU-701/1.5N	Soft Face Hammer - Nylon Tips	750g	5
HU-701/1.5P	Soft Face Hammer - Poly Tips	750g	5
HU-701/1.5NNP	Soft Face Hammer -Nylon & Poly Tips	750g	5
HU-701/1.5CCN	Soft Face Hammer - 2 Copper Tips & 1 Nylon Tip	750g	5

- Used for Assembly and Repair Operations to Minimise the Damage to Soft Surfaces
- Cast One Piece Head and Body
- Replaceable Tips
- Includes 3rd Tip In Handle
- Made in Australia

Soft Face Hammer 50mm

Replacement Tips Nylon -Poly & Copper



Part No	Description	Size	Pack Qty
HU-701/2N	Soft Face Hammer - Nylon Tips	1150g	5
HU-701/2P	Soft Face Hammer - Poly Tips	1150g	5
HU-701/2NP	Soft Face Hammer -Nylon & Poly Tips	1150g	5

- Used for Assembly and Repair Operations to Minimise the Damage to Soft Surfaces
- Cast One Piece Head and Body
- Replaceable Tips
- Made in Australia

Part No	Description	Size	Pack Qty
HU-777/N	Deadblow Tip Nylon	40mm	1
HU-778/N	Deadblow Tip Nylon	60mm	1
HU-701/5	Soft Face Tip Nylon	25mm	1
HU-701/6	Soft Face Tip Poly	25mm	1
HU-701/13	Soft Face Tip Copper	38mm	1
HU-701/14	Soft Face Tip Nylon	38mm	1
HU-701/15	Soft Face Tip Poly	38mm	1
HU-701/20Z	Soft Face Tip Nylon	50mm	1
HU-701/21	Soft Face Tip Poly	50MM	1

HAND TOOLS

general hand tools

Coping Saw

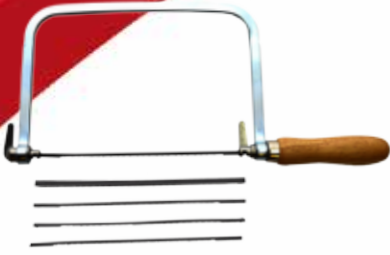

Part No	Description	Handle	Pack Qty
EG-605A	Coping Saw with 5 Blades	Timber	12

- Steel Frame for Durability
- 360 Degree Blade Rotation for Easy Access and Cutting
- Comes with 5 Blades; 1x Extra Fine, 1x Fine, 1x Hacksaw & 2x Medium
- Timber Handle

Mini Hacksaw



Part No	Description	Size	Pack Qty
SJ-MHS10	Mini Hacksaw	250mm	12

- Strong Lightweight Aluminium Body
- Comfort Soft Grip Handle with Thumb Grip
- Ideal for Cutting in Hard to Reach Places
- For Use with 300mm Hacksaw Blades

Hacksaw



Part No	Description	Size	Pack Qty
SJ-HS10	Hacksaw Box Frame	450mm	10

- Rigid Box Frame Design
- Blade Adjustment Allows for 55 & 90 Degree Cutting
- Accepts Standard 300mm Hacksaw Blades

Socket Adaptor Set



Part No	Description	Size	Pack Qty
EA-242	Square Drive Adaptor Set	4 Pce	10

- Converts Between 1/4" - 3/8" & 1/2" Drives
- Chrome Vanadium Steel
- Chrome Plated

Hole Saw Set



Part No	Description	Cut Depth	Pack Qty
EP-153/07	Hole Saw Set	20mm	6

- 9 Piece Set
- 7 Circular Blades
- Solid Metal Body
- Cut Depth 20mm
- Designed for Cutting Wood & Plastic

Hole Saw Set Extra Deep



Part No	Description	Cut Depth	Pack Qty
EP-157/07	Hole Saw Set - Extra Deep	44mm	6

- 9 Piece Set 7 Extra Deep Circular Blades
- Solid Metal Body
- Cut Depth 44mm
- For Cutting Wood & Plastic

Magnets 10pk



Part No	Description	Pack Qty
EG-299	Assorted Magnets 10pk	12

- Ideal for General use, School Projects & Around the Workshop. Spear & Jackson Magnets will Adhere to All Iron or Steel Surfaces
- 10 Piece Magnet Pack
- Pack Contains 10 x Disc Magnets

Horse Shoe Magnet



Part No	Description	Pack Qty
EG-216	Horse Shoe Magnet	12

- Ideal for General use, School Projects & Around the Workshop. Spear & Jackson Magnets will Adhere to All Iron or Steel Surfaces
- Total Size 90mm

Paint Marker



Part No	Description	Size	Pack Qty
EG-WPM	Paint Marker - White	2mm Tip	12

- All Purpose Paint Marker
- Suitable for Most Surfaces
- Weather Proof
- Xylene Free
- 2mm Tip

HAND TOOLS

general hand tools



Knife Retractable



Part No	Description	Size	Pack Qty
EG-031BFC	Knife Retractable	150mm	12
<ul style="list-style-type: none"> • All Metal Body • Includes 1x Blade • Accepts Standard 60mmx18mm Blades 			

Sharpening Stone



Part No	Description	Size	Pack Qty
EG-153/06	Sharpening Stone - 150mm	150mm x 50mm x 25mm	10
<ul style="list-style-type: none"> • Designed for your General Sharpening Needs • Silicon Carbide • Fine and Coarse Texture 			

Knife Lino



Part No	Description	Size	Pack Qty
SJ-LK75CP	Knife Lino	75mm	6
<ul style="list-style-type: none"> • Ideal for Cutting and Shaping Lino and Other Similar Materials • Chrome Plated Blade • FSC Rosewood Timber Handle 			

Knife Hacking



Part No	Description	Size	Pack Qty
SJ-HK115	Knife Hacking	120mm	6
<ul style="list-style-type: none"> • Used for the Removal of Old Putty From Window Frames • Heavy Duty Tapered Blade • Honed to a Very Sharp Edge • FSC Rosewood Timber Handle 			

Knife Shoe



Part No	Description	Size	Pack Qty
SJ-SK120	Knife Shoe	120mm	6
<ul style="list-style-type: none"> • Ideal for Trimming and Cutting Leather, Rubber & Plastics • FSC Rosewood Timber Handle 			

Riveter Deluxe



Part No	Description	Size	Pack Qty
SJ-HR10	Riveter Deluxe	255mm	5
<ul style="list-style-type: none"> • 4 Interchangeable Nose Pieces: 2,3,4 & 5mm • Suits Aluminium and Steel Rivets • Chrome Plated Body • Non Slip Handle Grips • Nose Spanner Included 			

Riveter Kit



Part No	Description	Size	Pack Qty
EG-2061	Riveter Kit cw 60 Rivets	260mm	12
<ul style="list-style-type: none"> • Includes 60 Rivets • 4 Interchangeable Nose pieces: 2.4,3.2,4 & 4.8mm • Cast Alloy Body • ***Not Suitable for Stainless Steel Rivets 			

Spring Clamps



Part No	Description	Size	Pack Qty
SJ-SC100	Spring Clamp	100mm	20
SJ-SC150	Spring Clamp	150mm	10
SJ-SC225	Spring Clamp	225mm	10
<ul style="list-style-type: none"> • Extra Heavy Duty Spring • High Clamping Force • Chrome Plated Steel Handles • Vinyl Coated Handles and Jaws 			

HAND TOOLS

wrecking bars & punches

Wrecking Bars



Part No	Type	Size	Pack Qty
SJ-WB300	Wrecking Bar	300mm	24
SJ-WB450	Wrecking Bar	450mm	24
SJ-WB600	Wrecking Bar	600mm	12
SJ-WB750	Wrecking Bar	750mm	10
SJ-WB900	Wrecking Bar	900mm	10

- Ideal for Opening Boxes & Removing Nails
- Heat Treated Carbon Steel with Polished Ends
- Hexagon Shaped Powder Coated Body
- Claw With Chisel End for Lifting & Prying

Wrecking Bars Heavy Duty



Part No	Type	Size	Pack Qty
SJ-WBHD300	Wrecking Bar Heavy Duty	300mm	24
SJ-WBHD450	Wrecking Bar Heavy Duty	450mm	20
SJ-WBHD600	Wrecking Bar Heavy Duty	600mm	12
SJ-WBHD750	Wrecking Bar Heavy Duty	750mm	12
SJ-WBHD900	Wrecking Bar Heavy Duty	900mm	12

- Ideal for Prying, Removing Nails & Demolition Work
- Heat Treated Heavy Duty Steel (Hrc42)
- Hexagon Shaped Powder Coated Body
- Sharpened And Polished Claw & Chisel Ends



Punch - Leather



Part No	Type	Handle	Pack Qty
EG-1509	Leather Punch	PVC	6

- Hole Sizes: 2.0mm, 2.5mm, 3.0mm, 3.5mm, 4.0mm, 4.5mm
- Revolving 6 Way
- PVC Hand Grips
- For Leather and other Soft Materials

Punch - Leather



Part No	Type	Handle	Pack Qty
SJ-LP20	Leather Punch	Soft Grip	12

- Hole Sizes: 2.0mm, 2.5mm, 3.0mm, 3.5mm, 4.0mm, 4.5mm
- Heavy Duty Construction
- Soft Grip
- For Leather and Other Soft Materials

Punch Plier



Part No	Type	Pack Qty
EG-1011PI	Punch Plier Eyelet Deluxe 7mm	10

- Heavy Duty Construction
- Polished Chrome Body
- Comfortable Vinyl Grips
- Supplied with 20 Eyelets

Punch Plier



Part No	Type	Pack Qty
EG-1013	Punch Plier Eyelet Deluxe 12mm	10

- Heavy Duty Construction
- Polished Chrome Body
- Comfortable Vinyl Grips
- Supplied with 20 Eyelets

Punch Grommet



Part No	Type	Pack Qty
EG-1007	Grommet Punch 10mm	10

- Supplied with 8 Grommets
- Hammer Required for Use

Grommets 10mm



Part No	Type	Pack Qty
EG-1007/S	Grommets 10mm	50

- 10mm
- For use with EG-1007
- 25 Pieces

Eyelets 7mm



Part No	Type	Pack Qty
EG-1011/200	Eyelets 7mm	50

- 7mm
- For use with EG-1011PI
- 200 Pieces

Eyelets 12mm



Part No	Type	Pack Qty
EG-1013C	Eyelets 12mm	50

- 12mm
- For use with EG-1013
- 20 Pieces

HAND TOOLS

measuring

Box Level Professional



Spear & Jackson PBL Levels are Available in a 16 Unit Merchandiser Display.



Box Level



Part No	Description	Size	Pack Qty
SJ-PBL600	Box Level Professional	600mm	5
SJ-PBL800	Box Level Professional	800mm	5
SJ-PBL1200	Box Level Professional	1200mm	5
SJ-PBL1800	Box Level Professional	1800mm	5
SJ-PBL2000	Box Level Professional	2000mm	5

- High Accuracy - 0.5mm/100mm
- CNC Milled on 4 Sides for Greater Accuracy
- Shock Proof Vial
- Dual Material Ergonomic Handgrips

Part No	Description	Size	Pack Qty
SJ-RDL600	Box Level	600mm	10
SJ-RDL800	Box Level	800mm	10
SJ-RDL1200	Box Level	1200mm	10

- Precision Machined Leveling Edges
- Shock Protecting End Caps
- Adjustable Rotating Vial
- Soft Touch Hand Grips

Torpedo Level



Part No	Description	Size	Pack Qty
SJ-TLC23M	Torpedo Level	230mm	12

- Ideal for Small Leveling Jobs
- 3 Vials for Flat, 90Deg & 45Deg Measuring
- Shock Absorbing End Caps
- Magnetic Base

Line Levels



Part No	Description	Size	Pack Qty
SJ-LL75M	Line Level Aluminium	75mm	24
SJ-LL75P	Line Level Plastic	75mm	24

- Ideal for Leveling with a String Line
- Clear Easy Read Vial

Cross Check Level



Part No	Description	Size	Pack Qty
SJ-CCL60	Cross Check Level	60mm	24

- Ideal for Leveling in 2 Planes
- Perfect For Caravans or Fridges
- 2 Vials in Fluoro Case
- Mounting Holes for Permanent Fixing

Bullseye Level



Part No	Description	Size	Pack Qty
SJ-BL45	Bullseye Level	45mm	24

- Levels in 2 Plane with a Single Bubble
- Perfect for Caravans or Fridges
- Mounting holes for Permanent Fixing

Bevel



Part No	Description	Size	Pack Qty
SJ-STB200	Bevel Sliding	200mm	10

- Used for the Setting and Duplicating of Angles in Carpentry
- 1.5mm Stainless Steel Blade
- Tough ABS Body

Bevel - Premium



Part No	Description	Size	Pack Qty
EG-100	Bevel Sliding Premium	205mm	6

- Used for the Setting and Duplicating of Angles in Carpentry
- All Metal Construction
- Stainless Steel Blade
- Made In Japan

Square Try & Mitre



Part No	Description	Size	Pack Qty
SJ-TMS200	Square Try and Mitre	200mm	25
SJ-TMS250	Square Try and Mitre	250mm	20
SJ-TMS300	Square Try and Mitre	300mm	20

- Stainless Steel Blade
- Premium Alloy Stock
- Easy Read Acid Etched Numerals

Carpenters Square



Part No	Description	Size	Pack Qty
EG-120	Carpenters Square	300x200mm	12
EG-6040	Carpenters Square	600x400mm	12

- Used for Measuring and Laying Out of Angles
- 1mm Scale
- Easy to Read White on Black Numerals

HAND TOOLS

measuring

Rulers

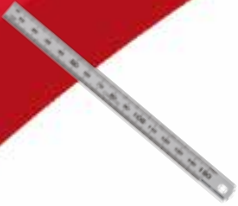

Part No	Description	Size	Pack Qty
SJ-SSR150	Ruler Stainless Steel	150mm	20
SJ-SSR300	Ruler Stainless Steel	300mm	10
SJ-SSR600	Ruler Stainless Steel	600mm	10
SJ-SSR1000	Ruler Stainless Steel	1000mm	10

- Premium Stainless Steel Blades
- Hanging Hole
- Easy Read Acid Etched Numerals
- Metric Only Graduation

Chalk Reel



Part No	Description	Size	Pack Qty
SJ-CRM100	Chalk Reel	30m/100ft	12

- Used for the Laying out of Lines for Building, Brick-work Etc
- Heavy Duty Metal Case

Contour Gauge



Part No	Description	Size	Pack Qty
EG-200CG	Contour Gauge	150mm	10

- Used to Duplicate Shapes and Forms
- All Metal Construction
- Connecting Plate for Joining Additional Gauges

Auto Centre Punch



Part No	Description	Size	Pack Qty
SJ-ACP125	Auto Centre Punch	125mm	12

- Used for the Centre Marking of Thin Sheet Material
- Adjustable Pressure
- **Hand Operated - Hammer Should NOT be Used

Tape Measure 8m



Part No	Description	Size	Pack Qty
SJ-3008M	Tape Measure	8m	6

- Auto Locking Tape Measure
- Metric Graduations
- Triple Riveted Hook
- Twin Magnetic Ends

Integrated Belt Clip & Wrist Band



Impact Absorbing Rubber Casing Offers a Better Grip & Greater Comfort

Auto Lock Blade System With a Push Release Button

Triple Riveted, Twin Magnetic End Hook For Internal & External Measurement

Metric Graduations x1mm

*** ENQUIRE ABOUT PERSONALISED TAPE MEASURES. TAPES IN YOUR COLOURS WITH YOUR LOGO.

Tape Measure 30m



Soft Feel Grip

High Impact Fluoro Case

3 Times Geared Speed Rewind

Tough Fibreglass Metric Only Tape

Easy Wind Roller Guides



Part No	Description	Size	Pack Qty
SJ-OST30	Tape Measure	30m	5

- 3 X Speed Rewind Tape Measure
- Metric Graduations
- High Impact Fluoro Case
- Easy Wind Roller Guides

HAND TOOLS workwear



The Spear & Jackson Workwear range offers premium leather, split leather and nylon combinations which comprehensively covers both professional and D.I.Y customers. The range features builder's aprons, nail bags, holsters and plenty of accessories.

Premium Top Grain or Oil Tanned Leather - Designed for everyday use by the true professional, allowing customers to have true confidence in the product.

Split Leather - A perfect alternative for D.I.Y or occasional users looking for great value products.

Nylon - Features a stylish look and strong 600DN polyester which make it a great choice for D.I.Y users.



Builders Apron 11 Pocket



Part No	Type	Material	Pack Qty
SJ-LPBA10	Builders Apron - 11 Pocket	Oil Tanned Leather	5

- Premium Oil Tanned Leather
- Rivet Reinforced Stress Points
- 2 X Metal Hammer Loops
- Measuring Tape Clip
- All Leather Belt
- Heavy Duty All Steel Buckle

Builders Apron 10 Pocket



Part No	Type	Material	Pack Qty
SJ-LPTG12	Builders Apron - 10 Pocket	Top Grain Leather	5

- Premium Top Grain Leather
- Heavy Duty Cotton Belt
- Adjustable Belt At Both Ends
- Tape Holder & Clip
- Belt Mounted Swing Hammer Holster
- Rivet Reinforced Stress Points

Nail Bag 7 Pocket



Part No	Type	Material	Pack Qty
SJ-LPBB7	Builders Nail Bag - 7 Pocket	Oil Tanned Leather	5

- Premium Oil Tanned Leather
- Rivet Reinforced Stress Points
- Swinging Hammer Loop
- Concealed Screwdriver Loops
- All Leather Belt
- Heavy Duty All Steel Buckle

HAND TOOLS workwear

Builders Apron 10 Pocket



Part No	Type	Material	Pack Qty
SJ-LDBA10	Builders Apron - 10 Pocket	Split Leather	5

- Split Leather
- Rivet Reinforced Stress Points
- Adjustable 50mm Webbing Belt
- Swinging Hammer Loop
- Tape Clip

Nail Bag 6 Pocket



Part No	Type	Material	Pack Qty
SJ-L45	Builders Nail Bag - 6 Pocket	Premium Split Leather	5

- Premium Split Leather
- Rivet Reinforced Stress Points
- Swinging Hammer Loop
- Adjustable 50mm Webbing Belt
- Tape Clip

Nail Bag 2 Pocket



Part No	Type	Material	Pack Qty
SJ-LDNB2	Builders Nail Bag - 2 Pocket	Split Leather	5

- Split Leather
- Rivet Reinforced Stress Points
- Adjustable 50mm Webbing Belt
- Tape Clip

Leather Work Belt



Part No	Type	Size	Pack Qty
SJ-LWBL	Work Belt	1200mm x 50mm	5

- Premium Top Grain Leather
- Rust Resistant Steel Buckle
- Heavy Duty
- Fits Waists 84 – 116cm

Webbing Belt



Part No	Type	Size	Pack Qty
SJ-LWBW	Webbing Belt	1200mm x 50mm	5

- Polyester Webbing – Plastic Buckle
- Extra Wide – 50mm
- Fits Waist Up To 120cm
- Fully Adjustable

Cotton Work Belt



Part No	Type	Material	Pack Qty
SJ-N120	Cotton Work Belt	600DN Polyester	6

- 600DN Polyester
- Heavy Duty All Cotton Belt
- Reinforced Eyelets
- All Steel Buckle

Plier & Secateur Holster



Part No	Type	Size	Pack Qty
SJ-LPH220	Plier Holster	220mm	5

- Top Grain Leather Body
- Split Grain Pencil Pouch
- Heavy Duty

Chisel & Pencil Pouch



Part No	Type	Size	Pack Qty
SJ-LCP240	Chisel Pouch	240mm	5

- Top Grain Leather Body
- Split Grain Pencil Pouch
- Heavy Duty
- Rivet Reinforced Stress Points
- Fits Up To 50mm Chisel

Hammer Holster



Part No	Type	Material	Pack Qty
SJ-LHHS	Hammer Holster	Leather / Steel	6

- Premium Top Grain Leather
- Heavy Duty
- Rivet Reinforced Stress Points
- Steel Hammer Loop

Tape Holster



Part No	Type	Material	Pack Qty
SJ-LTHC	Tape Holster	Top Grain Leather	6

- Premium Top Grain Leather
- Rivet Reinforced Stress Points
- Easy One Handed Removal
- Fits Most Tape Measures
- Heavy Duty

Mobile Phone Holster



Part No	Type	Material	Pack Qty
SJ-LPC	Phone Holster	Top Grain Leather	6

- Premium Top Grain Leather
- Rivet Reinforced Stress Points
- Suits Most Mobile Phone Sizes
- Belt Loop Accepts Work Belt Buckles
- Super Soft Interior

HAND TOOLS workwear

Nylon Builders Apron 13 Pocket



Part No	Type	Material	Pack Qty
SJ-N60	Builders Apron - 13 Pocket	600DN Polyester	6

- 600DN Polyester
- 13 Pockets & 4 Holsters
- 2x Hammer Loops & Tape Pouch
- Heavy Duty Cotton Belt With Belt Support

Nylon Builders Apron 11 Pocket



Part No	Type	Material	Pack Qty
SJ-N50	Builders Apron - 11 Pocket	600DN Polyester	6

- 600DN Polyester
- 11 Pockets & 6 Holsters
- Hammer Loops & Tape Pouch
- Rivet Reinforced Stress Points

Nylon Nail Bag 10 Pocket



Part No	Type	Material	Pack Qty
SJ-N30	Nail Bag - 10 Pocket	600DN Polyester	6

- 600DN Polyester
- 10 Pockets/Holders
- Extra Large Pocket for Bulk items
- 2 x Metal Hammer Loops

Nylon Nail Bag 6 Pocket



Part No	Type	Material	Pack Qty
SJ-N20	Nail Bag - 6 Pocket	600DN Polyester	6

- 600DN Polyester
- 6 Pockets/Holders
- Metal Hammer Loop
- Tape Clip

Nylon Nail Bag 2 Pocket



Part No	Type	Material	Pack Qty
SJ-N10	Nail Bag - 2 Pocket	600DN Polyester	6

- 600DN Polyester
- 2 Pockets & Tape Clip
- 50mm Nylon Belt
- Rivet Reinforced Stress Points

Nylon Drill Holster



Part No	Type	Material	Pack Qty
SJ-N130	Drill Holster	600DN Polyester	6

- 600DN Polyester
- Use With Existing Work Belt
- 5 Pockets/Holders
- 3 X Bit Holders
- Drill Securing Strap
- Rivet Reinforced

Nylon Electricians Tool Pouch



Part No	Type	Material	Pack Qty
SJ-N40	Electricians Pouch	600DN Polyester	6

- 600DN Polyester
- 15 Pockets/Holders
- Tape Chain
- Use With Existing Belt
- Rivet Reinforced

Tape Holster



Part No	Type	Material	Pack Qty
SJ-N110	Tape Holster	600DN Polyester	6

- 600DN Polyester
- Accepts Very Large Tapes
- Rivet Reinforced

Hammer Holster



Part No	Type	Material	Pack Qty
SJ-N70	Hammer Holster	600DN Polyester	6

- 600DN Polyester
- All Steel Swinging Loop
- Rivet Reinforced

Mobile Phone Holster



Part No	Type	Material	Pack Qty
SJ-N100	Mobile Holster	600DN Polyester	6

- 600 DN Polyester
- Securing Loop Sized For Work Belt Buckles
- Pouch Accepts Large Phones & PDA'S
- Use With Existing Belt

Plier Holster



Part No	Type	Material	Pack Qty
SJ-N80	Plier Holster	600DN Polyester	6

- 600DN Polyester
- Suits Most Pliers and Cutters
- Belt Loop
- Rivet Reinforced

STAEDTLER pencils & markers



Pencil Carpenter Red Medium 148/40



Part No	Type	Pack Qty
ST-148/40	Carpenters Pencil - Red Medium	72

- Ideal for Marking Timber, Plaster etc.
- Premium Graphite Core
- Break Resistant
- Super Bonded Lead

Pencil Carpenter Green Hard 148/50



Part No	Type	Pack Qty
ST-148/50	Carpenters Pencil - Green Hard	72

- Ideal for Marking Concrete, Brick Work, Underlay etc.
- Premium Graphite Core
- Break Resistant
- Super Bonded Lead

SINCE 1835, STAEDTLER HAS BEEN AT THE FOREFRONT OF WRITING INSTRUMENT INNOVATION. TRADITIONAL GERMAN QUALITY AND A CULTURE OF EXCELLENCE HAS MADE STAEDTLER ONE OF THE WORLD'S LEADING MANUFACTURER OF WRITING AND MARKING PRODUCTS.



*** ENQUIRE ABOUT PERSONALISED PENCILS

Chinagraph Pencils



Part No	Type	Colour	Pack Qty
ST-8080	Chinagraph Pencil	White	12
ST-8081	Chinagraph Pencil	Yellow	12
ST-8082	Chinagraph Pencil	Red	12
ST-8083	Chinagraph Pencil	Blue	12
ST-8089	Chinagraph Pencil	Black	12

- Wax Pencils For Marking On Glossy Or Other Surfaces Eg. Glass, Leather, Textiles, Stone, Metal, Wood And Plastic
- Cleans Off With A Clean Dry Cloth
- Waterproof

Marker Chisel Point 2mm - 5mm



Part No	Type	Colour	Pack Qty
ST-3502	Marker Chisel Point 2mm-5mm	Red	10
ST-3503	Marker Chisel Point 2mm-5mm	Blue	10
ST-3504	Marker Chisel Point 2mm-5mm	Orange	10
ST-3505	Marker Chisel Point 2mm-5mm	Green	10
ST-3506	Marker Chisel Point 2mm-5mm	Violet	10
ST-3509	Marker Chisel Point 2mm-5mm	Black	10

- Dry Safe Ink, Can Be Left Uncapped For Days Without Drying Out
- Locked Tip Ensures The Tip Remains In Place
- Waterproof, Xylene And Toluene Free

Marker Bullet Point 2mm



Part No	Type	Colour	Pack Qty
ST-3522	Marker Bullet Point 2mm	Red	10
ST-3523	Marker Bullet Point 2mm	Blue	10
ST-3524	Marker Bullet Point 2mm	Orange	10
ST-3525	Marker Bullet Point 2mm	Green	10
ST-3526	Marker Bullet Point 2mm	Violet	10
ST-3529	Marker Bullet Point 2mm	Black	10

- Dry Safe Ink, Can Be Left Uncapped For Days Without Drying Out
- Locked Tip Ensures The Tip Remains In Place
- Waterproof, Xylene And Toluene Free

Marker Bullet Point Compact 1mm - 2mm



Part No	Type	Colour	Pack Qty
ST-3422	Marker Bullet Point Compact 1mm - 2mm	Red	10
ST-3423	Marker Bullet Point Compact 1mm - 2mm	Blue	10
ST-3429	Marker Bullet Point Compact 1mm - 2mm	Black	10

- Handy Compact Size For Writing Or Marking
- Dry Safe Ink, Can Be Left Uncapped For Days Without Drying Out
- Locked Tip Ensures The Tip Remains In Place
- Waterproof, Xylene And Toluene Free

Marker Chisel Point Broad 2mm - 7mm



Part No	Type	Colour	Pack Qty
ST-3859	Marker Chisel Point Compact 2mm - 7mm	Black	5

- Especially Suited For Use Where A Thick Broad Line Is Required
- Dry Safe Ink, Can Be Left Uncapped For Days Without Drying Out
- Locked Tip Ensures The Tip Remains In Place
- Waterproof, Xylene And Toluene Free

Marker - Double Ended 0.6mm - 1.1mm



Part No	Type	Colour	Pack Qty
ST-3482	Marker - Double Ended 0.6mm & 1.1mm	Red	10
ST-3483	Marker - Double Ended 0.6mm & 1.1mm	Blue	10
ST-3489	Marker - Double Ended 0.6mm & 1.1mm	Black	10

- A Marker That Features Both Fine And Medium Tips
- Fine End For Writing 0.6mm
- Medium End For Marking 1.1mm
- Waterproof, Xylene And Toluene Free

FOOTPRINT

tools

BUILDERS TOOLS

PLUMBERS TOOLS

WOODWORKING TOOLS

MASONRY TOOLS

Footprint tools have a global reputation for high quality hand tools. This has been achieved through maintaining the control of their manufacturing operations within Footprint at their factory in Sheffield, England. Footprint forge and heat treat their own tools which are key to ensuring the highest quality hand tools able to survive the toughest of environments.



FOOTPRINT



Brick Bolsters



Part No	Type	Blade Size	Handle	Pack Qty
FP-1237/3	Brick Bolster	75mm	Plastic Moulded Grip	3
FP-1237/4.1/2	Brick Bolster	114mm	Plastic Moulded Grip	3
FP-1235	Masons Bolster	64mm	Plastic Moulded Grip	3

- Fully Drop Forged Handle & Blade, Building In More Strength
- Hardened & Tempered Blade For A Long Working Life
- Anti-Mushroom Head to Prevent Splintering & Prolong the Working Life
- Footprint Designed & Manufactured High Quality Hand Guard



Superior Strength in Lower Handle

Concrete Chisel



Part No	Type	Blade Size	Handle	Pack Qty
FP-582	Concrete Chisel	250mm x 19mm	Plastic Moulded Grip	3

- Fully Drop Forged Handle & Blade, Building In More Strength
- Hardened & Tempered Blade For A Long Working Life
- Anti-Mushroom Head to Prevent Splintering & Prolong the Working Life
- Footprint Designed & Manufactured High Quality Hand Guard

Scutch Chisels



Part No	Type	Blade Size	Handle	Pack Qty
FP-579/25	Scutch Chisel	25mm	Plastic Moulded Grip	3
FP-579/38	Scutch Chisel	38mm	Plastic Moulded Grip	3

- For use with Replaceable Scutch Combs & Doves to Aid in the Shaping of Stone & Brick Work
- Drop Forged Single Piece of Carbon Steel
- Hardened & Tempered
- Footprint Designed & Manufactured High Quality Hand Guard

Scutch Combs



SPECIAL ORDER ONLY

Part No	Type	Blade Size	Pack Qty
FP-5781/25	Scutch Combs	25mm (1")	10

- For Use with Scutch Holders / Hammers
- Used for Shaping and Preparing Stonework
- 25mm (1 Inch)
- Made From Hardened & Tempered Carbon Steel
- Zinc Coated to Delay Wear & Tear

Plugging Chisel



Part No	Type	Blade Size	Handle	Pack Qty
FP-1861	Plugging Chisel	280mm x 120mm	Plastic Moulded Grip	3

- Fully Drop Forged From High Carbon Steel
- Grooved Blade to Aid in the Rapid Extraction of Mortar Away From the Blade & Joint
- Anti-Mushroom Head to Prevent Splintering & Prolong the Working Life
- Fully Hardened & Tempered Blade

Cold Chisels



Part No	Type	Blade Size	Handle	Pack Qty
FP-591/8.3/4	Cold Chisel	200mm x 19mm	Moulded Grip	3
FP-591/9.7/8	Cold Chisel	230mm x 22mm	Moulded Grip	3
FP-591/10.3/4	Cold Chisel	250mm x 19mm	Moulded Grip	3
FP-591/10.1	Cold Chisel	254mm x 25mm	Moulded Grip	3
FP-591/12.1	Cold Chisel	300mm x 25mm	Moulded Grip	3

- Fully Drop Forged Handle And Blade, Building in More Strength
- Hardened & Tempered Blade
- Anti-Mushroom Head to Prevent Splintering, Prolonging Working Life
- Footprint Designed & Manufactured High Quality Hand Guard

The Footprint Range of carbon steel cold chisels are for use on stone, brick and other similar materials. Applications include shaping, cutting and chipping of stonework.

Forged with strong tapered blades, the 591 range is supplied with a strong High Visibility protective plastic moulded grip for added safety

Stripping Knife



SPECIAL ORDER ONLY

Part No	Type	Blade Size	Handle	Pack Qty
FP-2015/1	Stripping Knife	125mm x 25mm	Timber	6
FP-2015/112	Stripping Knife	125mm x 38mm	Timber	6
FP-2015/2	Stripping Knife	125mm x 50mm	Timber	12
FP-2015/212	Stripping Knife	125mm x 64mm	Timber	6
FP-2015/3	Stripping Knife	125mm x 75mm	Timber	6
FP-2015/4	Stripping Knife	125mm x 100mm	Timber	6

- Special Spring Tempered Carbon Steel, Retains Rigidity after Regular use
- Accurately Hardened & Tempered Blade
- Machine Ground Blade Giving a Great Edge
- Polished Blade to Prevent Premature Rusting
- Quality Hardwood Handle

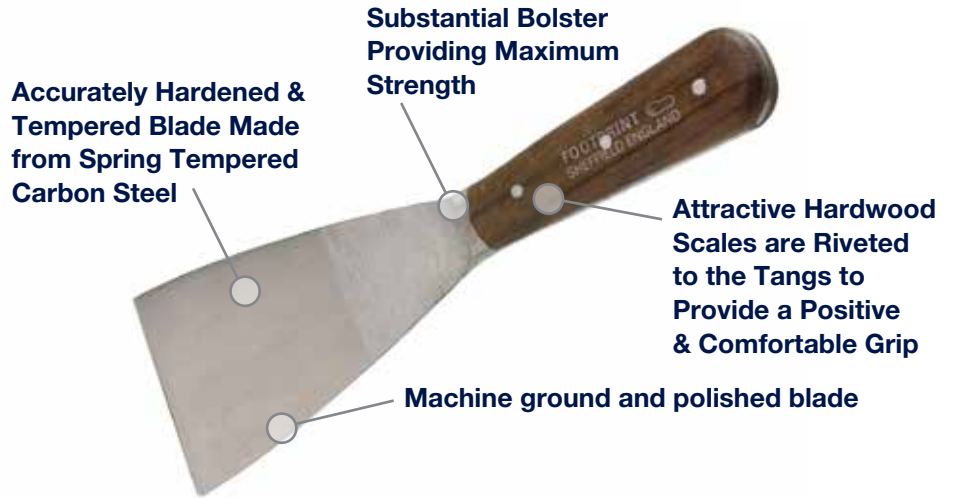

Filling Knife



SPECIAL ORDER ONLY

Part No	Type	Blade Size	Handle	Pack Qty
FP-2770/1	Filling Knife	125mm x 25mm	Timber	6
FP-2770/112	Filling Knife	125mm x 38mm	Timber	6
FP-2770/2	Filling Knife	125mm x 50mm	Timber	6
FP-2770/212	Filling Knife	125mm x 64mm	Timber	6
FP-2770/3	Filling Knife	125mm x 75mm	Timber	6
FP-2770/4	Filling Knife	125mm x 100mm	Timber	6

- Special Carbon Steel Providing an Extremely Flexible Blade
- Machine Ground Blade
- Polished Blade Giving a Smooth Finish & to Prevent Premature Rusting
- Quality Hardwood Handles

Professional quality filling knives are made from special spring tempered carbon steel.

The blades are machine ground and polished.

The tangs have shaped hardwood scales riveted to them which makes a strong comfortable grip.

Putty Knife - Skew Point



SPECIAL ORDER ONLY

Part No	Type	Blade Size	Handle	Pack Qty
FP-2017	Putty Knife - Skew Point	115mm	Timber	6

- Spring Tempered Carbon Steel Blade
- Hardened & Tempered Blade to Provide Long Life
- Skew Point
- Hardwood Handle

Putty Knife - Clipt Point



SPECIAL ORDER ONLY

Part No	Type	Blade Size	Handle	Pack Qty
FP-2030	Putty Knife - Clipt Point	115mm	Timber	6

- Spring Tempered Carbon Steel Blade
- Hardened & Tempered Blade to Provide Long Life
- Clipt Point
- Hardwood Handle

Scraper Sets



SPECIAL ORDER ONLY

Part No	Type	Blade Material	Pack Qty
FP-241	Scraper Set	Carbon Steel	6

- Made from Hard Wearing Saw Grade Steel
- Used to Give a Smooth Clean Finish to Wood
- Can be Re-Sharpened
- Set Contains the Following Sizes (All in Inches) 6 X 3, 5.5 X 2.5, 4 X 2

Scraper Sets



SPECIAL ORDER ONLY

Part No	Type	Blade Material	Pack Qty
FP-242	Scraper Set	Carbon Steel	6

- Made from Hard Wearing Saw Grade Steel
- Used to Give a Smooth Clean Finish to Wood
- Can be Re-Sharpened
- Gooseneck Shaped Scraper, Hollow Shaped Scraper & a 5.5 Inches x 2.5 Inches Rectangular Scraper

FOOTPRINT builders tools



The original "Footprint" Wrench. This traditional plumbers tool is an all purpose wrench and by means of the hardened fulcrum bolt, grips the workpiece tighter as more pressure is exerted. The screwdriver type end is useful for a number of different applications. Known Universally as "Footy's".

Moveable Bolt to Adjust Gripping Capabilities

Pressed Steel Handle Strengthened With A Forged Carbon Steel Wedge Insert With Hardened Teeth



Carefully Profiled Teeth Machined From High Quality Carbon Steel

Screwdriver Type End For General Application

Line Pins



Part No	Type	Size	Pack Qty
FP-620	Line Pins	160mm	50

- Drop Forged
- Hardened & Tempered Blades to prevent Bending, Snapping Wear & Tear
- Convex Blade to Hold the Line Pin Firmly in the Wall
- Extra Wide Head to Prevent Slipped Blows
- Size 160mm (61/4 Inch)
- Chrome Plated to Prevent Rusting

Pipe Wrench

698 Traditional Pattern



Part No	Type	Size	Pack Qty
FP-698/7	Pipe Wrench - Traditional	175mm	6
FP-698/9	Pipe Wrench - Traditional	225mm	6
FP-698/12	Pipe Wrench - Traditional	300mm	6

- Traditional Plumbers Tools Suitable for Plumbers, Gas Fitters & General Engineers
- Grips the Work Piece Tighter as More Pressure is Exerted
- Machine Ground & Precision Hardened Teeth, Which Won't Wear Easily
- Drop Forged Hook & Pressed Steel Frame
- Adjustable Screw to Alter the Jaw Capacity

Pipe Wrench

900 Thumbturn Pattern



Part No	Type	Size	Pack Qty
FP-900/7	Pipe Wrench - Thumbturn	175mm	6
FP-900/9	Pipe Wrench - Thumbturn	225mm	6
FP-900/12	Pipe Wrench - Thumbturn	300mm	6

- Traditional Plumbers Tools Suitable for Plumbers, Gas Fitters & General Engineers
- Grips the Work Piece Tighter as More Pressure is Exerted
- Machine Ground And Precision Hardened Teeth, They Won't Wear Easily
- Drop Forged Hook & Pressed Steel Frame
- Knurled Thumbturn Nut Enables Easy Jaw Adjustment

Sliding T-Bevels



SPECIAL ORDER ONLY

Part No	Type	Size	Handle	Pack Qty
FP-1254/7.1/2	Sliding T-Bevel	7.5" (190mm)	Beachwood	6
FP-1254/9	Sliding T-Bevel	9" (230mm)	Beachwood	6

- Used for Checking Angles, Marking Joints & Marking Across Boards
- Chemically Blued Blade to Prevent Corrosion
- Bevel Stock Made from High Quality Hard Wearing Beechwood
- Brass Wing Nut Screw Making Tightening & Loosening the Blade Simple
- Made in Sheffield, England
- **Also Available in Rosewood - Special Order Only**

Carpenters Square



Part No	Type	Size	Handle	Pack Qty
FP-1248/6	Carpenters Square	150mm	Timber	6
FP-1248/9	Carpenters Square	230mm	Timber	6

- Used for Marking Right Angles & Checking Squareness Between Joints
- Hard Wearing African Rosewood Stock
- Thick Brass Plate Fitted to the Stock for Protection from Damage & to Maintain Accuracy
- Tempered & Chemically Blued Blade to Prevent Corrosion
- **Also Available in Beech Wood - Special Order Only**

Marking Gauge



Part No	Type	Handle	Pack Qty
FP-1258	Marking Gauge	Timber	6

- Used for Marking a Line Parallel to a Straight Edge Prior to Sawing, Chiselling or Cutting
- Hardened Steel Pin for a Long Life
- Sturdy Beechwood Stem & Head
- Plastic Thumbscrew to Allow Ease of Adjusting the Stem & Head
- Radiussed Bottom Edge to Slide Easily on the Wood

Mortice & Marking Gauge



Part No	Type	Handle	Pack Qty
FP-1876	Mortice & Marking Gauge	Timber	6

- Used to Mark Wood to Make Mortice & Tenon Joints With a Simple Marking Gauge Pin on the Reverse Side to Mark Parallel Lines
- Hardened Steel Pins for a Long Life
- Hard Wearing Beechwood Stem & Head
- Plastic Thumbscrew to Adjust the Stem & with a Solid Brass Slide to Adjust the Pins

BUILDERS

tools

2015

BRICKWORKING TOOLS

PLASTERING TOOLS

CEMENT TOOLS

TILING TOOLS

CRAFTSMAN-MADE QUALITY FOR OVER TWO HUNDRED YEARS



BUILDERS' TOOLS brickworking tools

CRAFTSMAN-MADE QUALITY FOR
OVER TWO HUNDRED YEARS



WHS (William Hunt & Sons) started in 1782 making forged products in Oldbury near Birmingham. By 1960 their brick trowels were well known throughout the world with the 4" archaeology trowel deemed "the industry standard."

By expertly bringing together advanced technology, the best design and a genuine commitment to total quality, WHS offers a comprehensive range of superb pointing and brickwork trowels. Each of our trowels are crafted from the finest carbon steel with a solid forged blade and through tang for supreme strength. Handles are available in both traditional wooden or the latest soft feel ergonomic design. WHS is the first choice for ultimate comfort and performance.

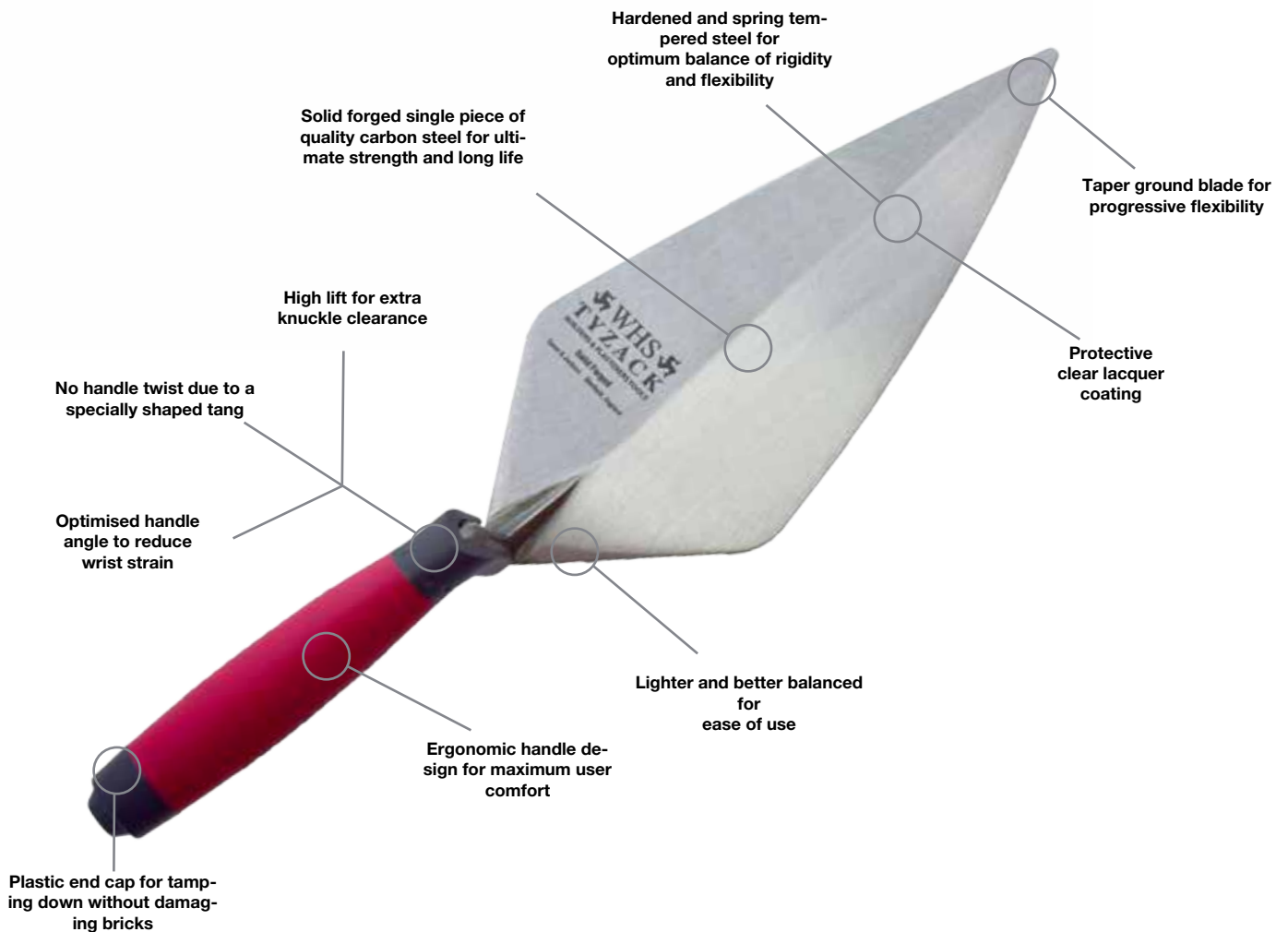

BUILDERS' TOOLS

brickworking tools

Brick Trowel

Timber Handle



Part No	Type	Size	Handle	Pack Qty
SJ-300	Brick Trowel 250mm	10"	Timber	12

- Carbon Steel Blade
- Blade Size 250mm x 123mm x 1.57mm
- Broad Heel Pattern
- FSC Timber Handle
- Laser Etched Blade

Brick Trowel

Soft Grip Handle



Part No	Type	Size	Handle	Pack Qty
SJ-500	Brick Trowel 250mm	10"	Soft Grip	12

- Carbon Steel Blade
- Blade Size 250mm x 123mm x 1.57mm
- Broad Heel Pattern
- Ergonomic Soft Grip Handle
- Laser Etched Blade

Brick Trowel

Timber Handle



Part No	Type	Size	Handle	Pack Qty
SJ-333	Brick Trowel 305mm	12"	Timber	6

- Carbon Steel Blade
- Blade Size 305mm x 139mm x 1.57mm
- Broad Heel Pattern
- FSC Timber Handle
- Laser Etched Blade

Brick Trowel

Soft Grip Handle



Part No	Type	Size	Handle	Pack Qty
SJ-555	Brick Trowel	12"	Soft Grip	6

- Carbon Steel Blade
- Blade Size 305mm x 139mm x 1.57mm
- Broad Heel Pattern
- Ergonomic Soft Grip Handle
- Laser Etched Blade

Brick Trowel

Soft Feel Handle, Capped



Part No	Type	Size	Handle	Pack Qty
SJ-10112SF	Brick Trowel	12"	Soft Feel	5

- Carbon Steel Blade
- Blade Size 305mm x 156mm x 1.86mm
- Broad Heel Pattern
- Soft Feel Handle, Capped
- Laser Etched Blade

Brick Trowel

Soft Feel Handle, Capped



Part No	Type	Size	Handle	Pack Qty
SJ-10712SF	Brick Trowel	12"	Soft Feel	5

- Carbon Steel Blade
- Blade Size 305mm x 150mm x 1.86mm
- Philadelphia Pattern
- Soft Feel Handle, Capped
- Laser Etched Blade

Brick Trowel

Acetate Handle



Part No	Type	Size	Handle	Pack Qty
SJ-20212CA	Pointing	12"	Acetate	5

- Carbon Steel Blade
- Forged Blade for Maximum Strength
- Blade Size 305mm x 156mm x 1.86mm
- Broad Heel Pattern
- Acetate Handle



BUILDERS' TOOLS

brickworking tools

Pointing Trowel

Timber Handle



Part No	Type	Size	Handle	Pack Qty
SJ-11105N	Pointing Trowel	125mm 10"	Timber	5

- Carbon Steel Blade
- Blade Size 125mm x 58mm x 1.27mm
- FSC Timber Handle
- Laser Etched Blade

Pointing Trowel

Soft Feel Handle, Capped



Part No	Type	Size	Handle	Pack Qty
SJ-11105SF	Pointing Trowel	125mm 10"	Soft Feel	5

- Carbon Steel Blade
- Blade Size 125mm x 58mm x 1.27mm
- Soft Feel Handle, Capped
- Laser Etched Blade



Pointing Trowel

Timber Handle



Part No	Type	Size	Handle	Pack Qty
SJ-320	Pointing Trowel	150mm 12"	Timber	12

- Carbon Steel Blade
- Blade Size 150mm x 80mm x 1.27mm
- FSC Timber Handle
- Laser Etched Blade

Pointing Trowel

Soft Grip Handle



Part No	Type	Size	Handle	Pack Qty
SJ-520	Pointing Trowel	150mm 12"	Soft Grip	12

- Carbon Steel Blade
- Blade Size 150mm x 80mm x 1.27mm
- Ergonomic Soft Grip Handle
- Laser Etched Blade

Pointing Trowel

Soft Feel Handle



Part No	Type	Size	Handle	Pack Qty
SJ-11106SF	Pointing Trowel	150mm 12"	Soft Feel	5

- Carbon Steel Blade
- Blade Size 150mm x 64mm x 1.27mm
- Soft Feel Handle, Capped
- Laser Etched Blade

Pointing Trowel

Timber Handle



Part No	Type	Size	Handle	Pack Qty
SJ-325	Pointing Trowel	175mm 14"	Timber	12

- Carbon Steel Blade
- Blade Size 175mm x 92mm x 1.27mm
- FSC Timber Handle
- Laser Etched Blade

Pointing Trowel

Soft Grip Handle



Part No	Type	Size	Handle	Pack Qty
SJ-525	Pointing Trowel	175mm 14"	Soft Grip	12

- Carbon Steel Blade
- Blade Size 175mm x 92mm x 1.27mm
- Ergonomic Soft Grip Handle
- Laser Etched Blade

Archaeology Trowel

Soft Feel Handle



Part No	Type	Size	Handle	Pack Qty
SJ-11104SFARCH	Archaeology - Soft Feel	4"	Soft Feel	10

- Solid Forged Blade
- Soft Feel Handle With Integral Finger Guard
- High Tang For Good Knuckle Clearance
- Thicker, More Rigid Blade For Extra Strength

BUILDERS' TOOLS

brickworking tools



Brick Hammer All Steel



Part No	Description	Size	Pack Qty
SJ-BRH24AS	Brick Hammer All Steel	24Oz / 680g	6

- Forged One Piece Head and Handle
- Grip Mechanically Pinned To Shaft
- Dual Material Soft Grip Handle
- Fully Polished Head

Brick Hammer Fibreglass



Part No	Description	Size	Pack Qty
SJ-BRH24FG	Brick Hammer Fibreglass	24 Oz/680g	6

- Tough Fibreglass Handle
- Fully Polished Head
- Dual Material Soft Grip Handle

Masonry Brush



Part No	Type	Size	Handle	Pack Qty
SJ-829	Masonry Brush	165mm	Wooden	12

- Brush Size 165mm x 90mm
- Bristles 5 Rows
- Sturdy Timber Handle with Hang Hole
- Flexible Nylon Bristles

Brick Bolster D.I.Y



Part No	Type	Blade Size	Handle	Pack Qty
SJ-DBB	Brick Bolster	115mm	Plastic	12

- Dropped Forged 115mm Blade
- Knuckle Guard on Grip
- Hardened Plastic Safety Grip
- High Visibility Colouring

Electricians Bolster



Part No	Type	Blade Size	Handle	Pack Qty
SJ-EB	Electricians Bolster	75mm	Plastic	6

- Dropped Forged 75mm Blade
- Knuckle Guard on Grip
- Hardened Plastic Safety Grip
- High Visibility Colouring

Brick Bolster Professional



Part No	Type	Blade Size	Handle	Pack Qty
SJ-PBB	Professional Brick Bolster	115mm	Plastic	4

- Dropped Forged 115mm Strengthened Blade
- Knuckle Guard on Grip
- Hardened Plastic Safety Grip
- High Visibility Colouring

BUILDERS' TOOLS

brickworking tools

Brickline 50M



Part No	Type	Length	Colour	Pack Qty
SJ-8/50M	Brickline 8 Strand	50M	White	12
SJ-8/50M-LG	Brickline 8 Strand	50M	Light Green	12
SJ-8/50M-O	Brickline 8 Strand	50M	Orange	12
SJ-8/50M-P	Brickline 8 Strand	50M	Pink	12

- 8 Strand Nylon
- 50 Meters
- Available in White / Light Green / Orange & Pink
- Supplied With 12 Unit Display Case

Brickline 100M



Part No	Type	Length	Colour	Pack Qty
SJ-8/100M	Brickline 8 Strand	100M	White	12
SJ-8/100M-LG	Brickline 8 Strand	100M	Light Green	12
SJ-8/100M-O	Brickline 8 Strand	100M	Orange	12
SJ-8/100M-P	Brickline 8 Strand	100M	Pink	12

- 8 Strand Nylon
- 100 Meters
- Available in White / Light Green / Orange & Pink
- Supplied With 12 Unit Display Case

Brickline 100M



Part No	Type	Length	Colour	Per Pack
SJ-8/100MAST	Brickline 8 Strand	100M	White	2
	Brickline 8 Strand	100M	Light Green	4
	Brickline 8 Strand	100M	Orange	4
	Brickline 8 Strand	100M	Pink	2

- 8 Strand Nylon
- 100 Meters
- Includes 2x White 4x Light Green 4x Orange 2x Pink
- Supplied With 12 Unit Display Case.

Brickline 50M



Part No	Type	Length	Colour	Pack Qty
SJ-12/50M	Brickline 12 Strand	50M	White	12

- 12 Strand Nylon
- 50 Meters
- Available in White
- Supplied With 12 Unit Display Case.

Brickline 100M



Part No	Type	Length	Colour	Pack Qty
SJ-12/100M-LG	Brickline 12 Strand	100M	Light Green	12
SJ-12/100M-P	Brickline 12 Strand	100M	Pink	12

- 12 Strand Nylon
- 100 Meters
- Available in Light Green & Pink
- Supplied With 12 Unit Display Case.



Brickline 500M



Part No	Type	Length	Colour	Pack Qty
SJ-12/500M-LG	Brickline 12 Strand	500M	Light Green	4

- 12 Strand Nylon
- 500 Meters
- Available in Light Green

Rubber Line Blocks



Part No	Type	Colour	Pack Qty
SJ-RLB	Line Block	Light Green	24
SJ-RLB/O	Line Block	Orange	24

- Blocks Are Angled At 87.5° So That, When Under Tension, They Square Up Into The Corner Of The Brick For A Better Grip And A More Stable Line
- Durable One Piece Moulded Rubber
- Available In Light Green & Orange
- Ribbed To Prevent Slippage When In Use
- Supplied With 24 Piece Coloured Display Box (See Image Right)



The Spear & Jackson Line Block is used in conjunction with string line to mark out the path for a new course of bricks.

BUILDERS' TOOLS

brickworking tools

Brick Jointers

Carbon Steel



Part No	Type	Size	Pack Qty
SJ-21238C	Brick Jointer	13mm x 10mm	10
SJ-21258B	Brick Jointer	13mm x 16mm	10

- Suitable for Finishing of Mortar Joints in Brick & Block Walls
- Carbon Steel Construction
- Profile: Convex

Sled Jointers

Soft Grip Handle



Part No	Type	Size	Pack Qty
SJ-BJ10	Sled Jointer	10mm	6
SJ-BJ12	Sled Jointer	12mm	6

- Carbon Steel
- 10mm & 12mm Sizes
- Ergonomic Soft Grip Handle
- Suitable for Finishing of Mortar Joints in Brick & Block Walls

Profile Clamps

Soft Grip Handle



Part No	Type	Size	Pack Qty
SJ-PC180	Profile Clamp	180mm	6
SJ-PC300	Profile Clamp	300mm	6

- Used For Holding A Profile Pole Against Brickwork When Setting Course Heights
- 180mm & 300mm Sizes
- Comfortable Soft Grip Handle
- Adjustable Depth
- Zinc Plated Finish

Joint Raker

Soft Grip Handle



Part No	Type	Handle	Pack Qty
SJ-RAKER	Joint Raker	Soft Grip	6

- Skate Wheel Joint Raker
- Comfortable Soft Grip Handle
- Adjustable Rake Depth
- Easy Roll Skate Wheels
- High Lift Knuckle Clearance

Soft Grip Ergonomic Handle

High Lift Knuckle Clearance



Steel Wheels for Enhanced Durability

Brick Carrier

Soft Grip Handle



Part No	Type	Jaw Capacity	Pack Qty
SJ-BT	Brick Carrier	400mm - 500mm	6

- Strong Metal Frame
- Comfortable Soft Grip Handle
- Adjustable for Bricks & Blocks
- Zinc Plated Finish
- 400 - 500mm Jaw Capacity

Line Pins

Twin Pack



Part No	Type	Size	Pack Qty
SJ-LP2P	Line Pine Twin Pack	155mm x 20mm	10

- Line Pins Are Used With Stringline to Mark Out a Course of Bricks
- 2 Pack
- Wide Head for Striking
- Shaped Tip for Holding in Mortar
- Forged for Extra Strength

Dutch Pins



Part No	Type	Size	Pack Qty
SJ-DP150R	Dutch Pin Round	150mm (L) x 12.3mm (D)	12

- Dutch Pins Are Used For Holding A Profile Pole Against A Wall When There Is No Ground Contact
- Professional Dutch Pin
- Flange to hold Profile Pole
- Shaped Tip for Holding in Mortar
- Forged for Extra Strength

BUILDERS' TOOLS

plastering tools

Through a combination of advanced technologies, optimum design and a commitment to quality, we are able to offer a comprehensive range of Plastering and Drywall tools for the Professional and DIY user alike.

Tyzack Plastering Floats have been designed with the professional user in mind. With Craftsman set, pre worn blades these are ready for use by the busy professional. Under the Spear & Jackson brand there is a comprehensive range of Plastering tools for both the tradesman and DIY user. So, whatever your target market, customer expectation levels and sourcing criteria, Tyzack and Spear & Jackson are the best and only ranges you should turn to.

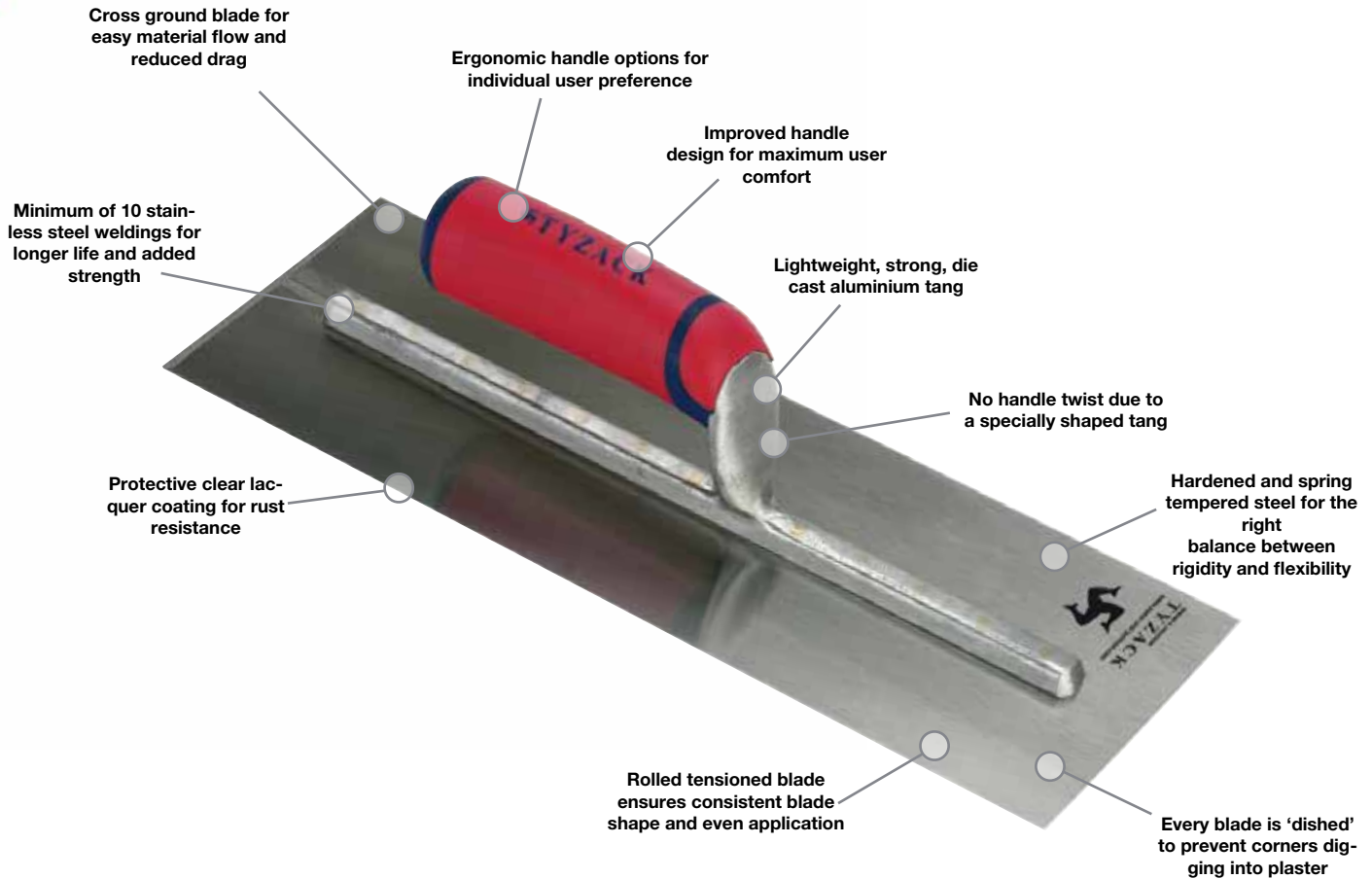

A HISTORY OF QUALITY IN PLASTERING



Ever since Joseph Tyzack introduced steel blades to replace traditional wooden trowels in the late 19th century, the TYZACK name has set the standard for quality plastering tools. Another innovation was a patented design enabling the blade to be attached to the tang without the need for the rivets to go right through the blade thereby ensuring a totally smooth finish. Importantly, all TYZACK trowels are hand 'dished' by time served craftsmen to create a convex blade, solving the problem of 'drag lines' when finishing.

Additional features such as hardened and spring tempered blades also ensure that TYZACK tools are strong, durable and give outstanding performance. Available in both carbon and stainless steel with a variety of blade sizes and ergonomic handle options, TYZACK is the ultimate in comfort and performance.

Blade Thickness	Application
0.24" / 0.6mm	Finishing & General Use
0.32" / 0.8mm	Laying-on
0.56" / 1.4mm	Flooring

- Different Blade Thicknesses For Different Applications
- Stainless And Carbon Steel Options
- Available With Double Hang Versions For Added Strength
- Individually Hand Set By A Craftsmen

BUILDERS' TOOLS

plastering tools

'READY TO GO' FINISHING TROWELS

Pre-worn to professional standards, our revolutionary trowel is READY TO GO right from the start! Featuring 'rounded' front corners to prevent 'drag-lines' and a pre-worn 'fine edge' on both sides for ultimate control in the finish.

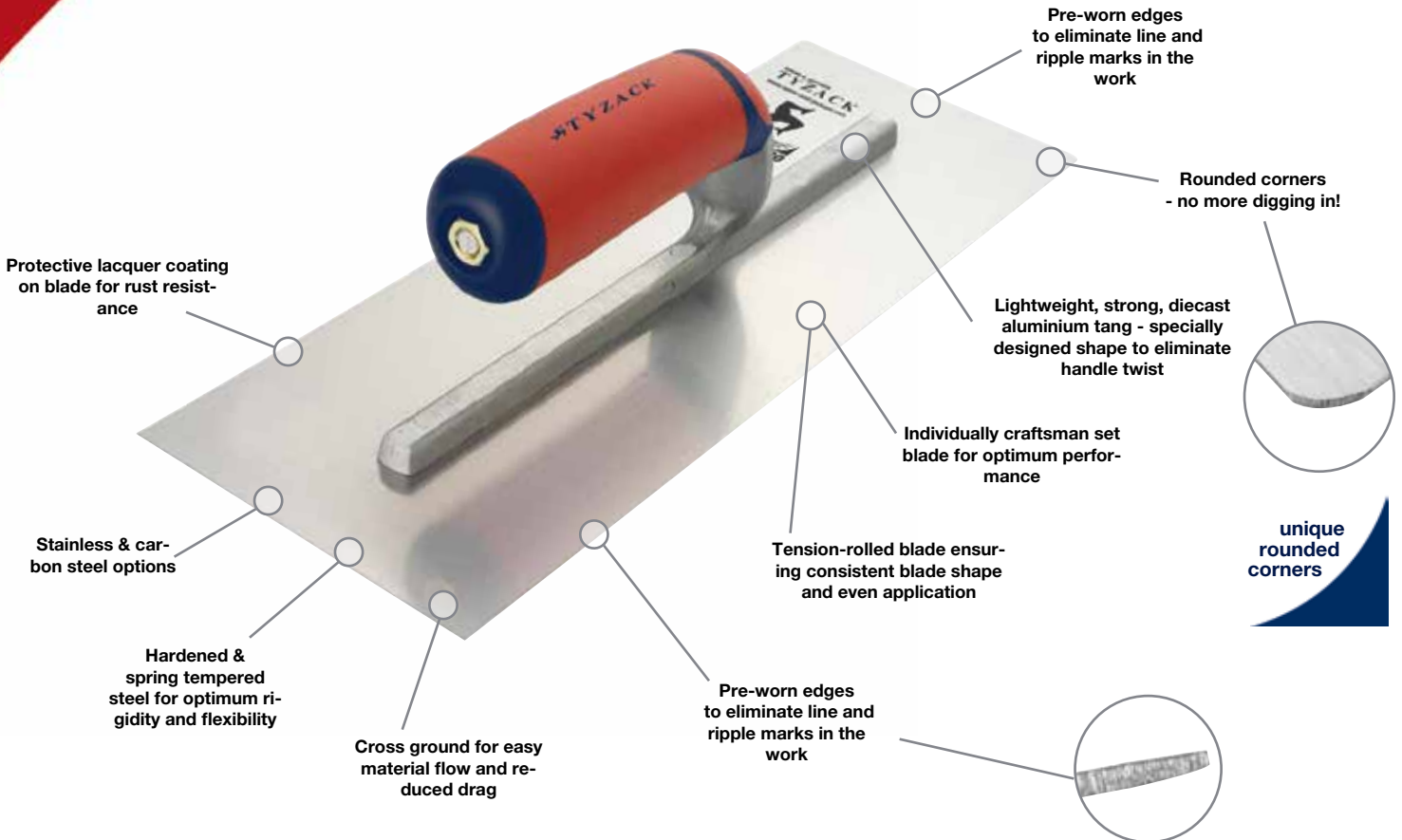

BUILDERS' TOOLS

plastering tools

Plasterers Float

Timber Handle



Part No	Type	Size	Handle	Pack Qty
SJ-380	Plasterers Float	280mm	Timber	6

- Blade Size 280mm x 114mm x 0.57mm
- Carbon Steel Blade
- Aluminium Tang
- FSC Timber Handle

Plasterers Float

Soft Grip Handle



Part No	Type	Size	Handle	Pack Qty
SJ-550	Plasterers Float	280mm	Soft Grip	6

- Blade Size 280mm x 114mm x 0.57mm
- Carbon Steel Blade
- Aluminium Tang
- Ergonomic Soft Grip Handle

Plastering Floats

Soft Feel Handle, Capped



Part No	Type	Size	Handle	Pack Qty
SJ-10611CSF	Plastering Float	280mm	Soft Feel	10

- Blade Size 280mm x 120mm x 0.59mm
- Carbon Steel Blade
- Aluminium Tang
- Ergonomic Soft Grip Handle

Plasterers Float

Soft Feel Handle



Part No	Type	Size	Handle	Pack Qty
SJ-10611SSF	Plasterers Float	280mm	Soft Feel	10

- Blade Size 280mm x 120mm x 0.59mm
- Stainless Steel Blade
- Aluminium Tang
- Ergonomic Soft Grip Handle

Plasterers Float

Soft Feel Handle, Capped



Part No	Type	Size	Handle	Pack Qty
SJ-13100RSF	Plasterers Float	280mm	Soft Grip	5

- Blade Size 280mm x 110mm x 0.68mm
- Carbon Steel Blade
- Aluminium Tang
- Ergonomic Soft Grip Handle

Plasterers Float

Soft Feel Handle



Part No	Type	Size	Handle	Pack Qty
SJ-13458BISF	Plasterers Float	330mm	Soft Grip	5

- Blade Size 330mm x 117mm x 0.59mm
- Radiused Corners Pre Worn
- Stainless Steel Blade
- Aluminium Tang
- Ergonomic Soft Grip Handle

Plasterers Float

Soft Feel Handle



Part No	Type	Size	Handle	Pack Qty
SJ-14458BISF	Plasterers Float	355mm	Soft Feel	5

- Blade Size 355mm x 117mm x 0.59mm
- Radiused Corners Pre Worn
- Stainless Steel Blade
- Aluminium Tang
- Ergonomic Soft Grip Handle

External Corner Trowel



Part No	Type	Size	Handle	Pack Qty
SJ-715C	External Corner Trowel	125mm	Soft Grip	10

- Used To Produce A Tight, Bubble Free External Corner Joint
- Blade Size 125mm x 100mm x 100mm
- Stainless Blade For Longer Life
- Offset Blade Allows You to Work Right Up to Ceiling Down to the Floor or Skirting
- Soft Feel Handle For Extra Comfort
- Radiused Corners

Internal Corner Trowel



Part No	Type	Size	Handle	Pack Qty
SJ-714B	Internal Corner Trowel	125mm	Soft Grip	10

- Used To Produce A Tight, Bubble Free Internal Corner Joint
- Blade Size 125mm x 100mm x 100mm
- Stainless Blade For Longer Life
- Offset Blade Allows You to Work Right Up to Ceiling / Down to the Floor or Skirting
- Soft Feel Handle For Extra Comfort
- Leading Corners with Radiused Edgers

BUILDERS' TOOLS

plastering tools

Gauging Trowel

Timber Handle



Part No	Type	Size	Handle	Pack Qty
SJ-330	Gauging Trowel 175mm	14"	Timber	12

- Carbon Steel Blade
- Blade Size 175mm x 87mm x 1.27mm
- FSC Timber Handle
- Laser Etched Blade

Gauging Trowel

Soft Grip Handle



Part No	Type	Size	Handle	Pack Qty
SJ-530	Gauging Trowel 175mm	14"	Soft Grip	12

- Carbon Steel Blade
- Blade Size 175mm x 87mm x 1.27mm
- Ergonomic Soft Grip Handle
- Laser Etched Blade

Gauging Trowel

Soft Feel Handle



Part No	Type	Size	Handle	Pack Qty
SJ-11507SF	Gauging Trowel 175mm	14"	Soft Feel	5

- Carbon Steel Blade
- Blade Size 175mm x 80mm x 1.48mm
- Soft Feel Handle, Capped
- Laser Etched Blade

Gauging Trowel

Timber Handle



Part No	Type	Size	Handle	Pack Qty
SJ-335	Gauging Trowel 200mm	16"	Timber	12

- Carbon Steel Blade
- Blade Size 200mm x 95mm x 1.27mm
- FSC Timber Handle
- Laser Etched Blade

Gauging Trowel

Soft Grip Handle



Part No	Type	Size	Handle	Pack Qty
SJ-535	Gauging Trowel 200mm	16"	Soft Grip	12

- Carbon Steel Blade
- Blade Size 200mm x 95mm x 1.27mm
- Ergonomic Soft Grip Handle
- Laser Etched Blade

Gauging Trowel

Soft Feel Handle



Part No	Type	Size	Handle	Pack Qty
SJ-11508SF	Gauging Trowel 200mm	14"	Soft Feel	5

- Carbon Steel Blade
- Blade Size 200mm x 80mm x 1.48mm
- Soft Feel Handle, Capped
- Laser Etched Blade

Bucket Trowel

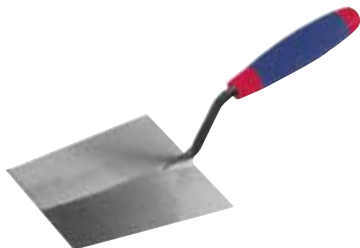

Part No	Type	Size	Handle	Pack Qty
SJ-10565BSF	Bucket Trowel	165mm	Soft Grip	10

- Ideal For Mixing And Removing Mortar And Plaster From Buckets
- Blade Size 180mm X 120mm To 97mm
- Cropped Blade Profile for Easy Reach Right to the Bottom of the Bucket
- Extra High Tang For Increased Knuckle Clearance
- Soft Feel Handle For Extra Comfort

Plasterers Hawk



Part No	Type	Size	Handle	Pack Qty
SJ-370	Plasterers Hawk	330mm	Timber	6

- Blade Size 330mm x 330mm x 1.71mm
- Lightweight Aluminium
- FSC Timber Handle
- Machined Non Slip Handle

Plasterers Hawk



Part No	Type	Size	Handle	Pack Qty
SJ-13713SF	Plasterers Hawk	330mm	Soft Grip	10

- Blade Size 330mm x 330mm x 2.07mm
- Lightweight Aluminium
- Ergonomic Soft Grip Handle
- Machined Non Slip Handle

BUILDERS' TOOLS

plastering tools

Sponge Float



Part No	Type	Size	Handle	Pack Qty
SJ-50106	Sponge Float	250mm x 100mm	Plastic	10

- Pine Timber Blade
- Blade Size 250mm x 100mm
- Sponge Thickness 15mm
- Comfort Plastic Handle

Sponge Float



Part No	Type	Size	Handle	Pack Qty
SJ-PD101	Sponge Float	140mm x 230mm	Poly	10

- Blade Size 140mm x 230mm
- Sponge Thickness 20mm
- One Piece Poly Handle & Base

Sponge Float



Part No	Type	Blade Size	Handle	Pack Qty
SJ-PSF400	Sponge Float	280mm x 106mm	Poly	6
SJ-PSF500	Sponge Float	340mm x 148mm	Poly	6

- Sponge Thickness 30mm
- One Piece Poly Handle & Base

Replacement Sponge

Available for SJ-PSF400 & SJ-PSF500

Part No	Pack Qty
SJ-PSF400SP	6
SJ-PSF500SP	6

Polyurethane Float



Part No	Type	Size	Handle	Pack Qty
SJ-PA101	Polyurethane Float	140mm x 280mm	Poly	6

- Base Size 140mm x 280mm x 15mm
- One Piece Poly Handle & Base
- Textured Surface
- Lightweight

Polyurethane Float



Part No	Type	Size	Handle	Pack Qty
SJ-PA102	Polyurethane Float	180mm x 320mm	Poly	6

- Base Size 180mm x 320mm x 15mm
- One Piece Poly Handle & Base
- Textured Surface
- Lightweight

Polyurethane Float



Part No	Type	Size	Handle	Pack Qty
SJ-PA103	Polyurethane Float	200mm x 360mm	Poly	6

- Base Size 200mm x 360mm x 15mm
- One Piece Poly Handle & Base
- Textured Surface
- Lightweight

Polyurethane Float



Part No	Type	Size	Handle	Pack Qty
SJ-PA105	Polyurethane Float	140mm x 280mm	Poly	6

- Base Size 150mm x 350mm x 15mm
- One Piece Poly Handle & Base
- Textured Surface
- Lightweight

Polypropylene Float



Part No	Type	Size	Handle	Pack Qty
SJ-PF100	Polypropylene Float	280mm x 108mm	Polypropylene	6

- Base Size 280mm x 108mm
- One Piece Polypropylene Handle & Base
- Textured Surface
- Heavy Duty

Polypropylene Float



Part No	Type	Size	Handle	Pack Qty
SJ-PF200	Polypropylene Float	340mm x 148mm	Polypropylene	6

- Base Size 340mm x 148mm
- One Piece Polypropylene Handle & Base
- Textured Surface
- Heavy Duty

BUILDERS' TOOLS

plastering tools

Poly Sanding Float



Polypropylene Handle & Base

Texture Grip for Extra Comfort & Control

Durable Sandpaper Sheet

Screwdown Clamps At Each End

Part No	Type	Size	Handle	Pack Qty
SJ-PHS300	Poly Sanding Float	280mm x 108mm	Timber	6

- Base Size 280mm x 108mm
- One Piece Polypropylene Handle & Base
- Neoprene Cushion to Improve Sanding Capabilities
- Mounting Bars with Screw Clamps for Sand Paper

Rendering Float

Plastic Handle



Part No	Type	Size	Handle	Pack Qty
SJ-RF280	Rendering Float	280mm	Soft Grip	6

- Blade Size 280mm x 130mm
- Ribbed Non Slip Flexible Plastic Handle
- Plastic Blade

Small Tools



Part No	Type	Size	Material	Pack Qty
SJ-360	Small Tool	13mm	Carbon Steel	10
SJ-362	Small Tool	16mm	Carbon Steel	10
SJ-364	Small Tool	19mm	Carbon Steel	10
SJ-366	Small Tool	25mm	Carbon Steel	10

- 13mm/16mm/19mm/25mm
- Carbon Steel
- Forged & Stamped Steel Body
- Hand Finished
- Flexible Head & Tip

Support Prop



Part No	Type	Size	Handle	Pack Qty
SJ-713A	Support Prop	0mm	Steel	1

- Pistol Grip Extending Action
- Extends from 1.15m to 2.90m
- Universally Jointed Feet
- Recommended Load Capacity 30Kg
- Provides an Extra Support on Site by Holding in Position Plasterboard to Ceilings

Mixing Paddle

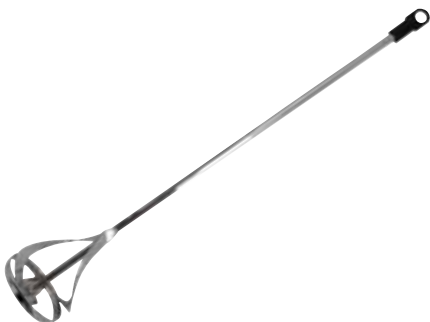

Part No	Type	Size	Handle	Pack Qty
SJ-710X	Mixing Paddle	600mm	Steel	5

- Anti-rust chrome finish
- Small, Medium or Large Diameter Head
- Head Diameter 100mm
- Shaft Length 600mm
- Hanging Hook

Board Lifter



Part No	Type	Material	Pack Qty
SJ-712Z	Board Lifter	Aluminium	5

- Tapered Front End Slides Easily Under Boards
- Great For Lifting Plaster Sheets, Timber, Doors.
- Reduces Back Strain



BUILDERS' TOOLS

plastering tools

Jab Saw



Part No	Type	Size	Handle	Pack Qty
SJ-JS10	Jab Saw	330mm	Soft Grip	10

- Comfortable Suregrip® Handle
- Teeth Cut On Forward & Reverse Stroke
- Pointed to Drive Through Plasterboard
- Ideal for use on Timber, Hardwood, Chipboard & MDF

Jab Saw - Deluxe



Part No	Type	Size	Handle	Pack Qty
SJ-JSD20	Jab Saw - Deluxe	330mm	Soft Grip	12

- Superior Fast Action Blade
- Impulse Hardened Cross Cut Teeth
- Sharpened Tip for Plunge Cuts
- Bi Material Soft Grip Handle
- Ideal for use on Timber, Hardwood, Chipboard & MDF

Compass Saw



Part No	Type	Size	Handle	Pack Qty
SJ-CS10	Compass Saw	300mm	Soft Grip	10

- 9 TPI
- Induction Hardened Double Ground Teeth
- Bi Material Soft Grip Handle
- For Cutting in Hard to Reach Places
- Ideal For Cutting Wood, Masonite And Plasterboard



Bi Material Ergonomic Soft Grip Handle



Taping Knives



Part No	Description	Size	Handle	Pack Qty
SJ-716D	Taping Knife	225mm	Soft Grip	5
SJ-717E	Taping Knife	300mm	Soft Grip	5

- Spreads Initial Coats Of Compound Over Plaster Joints & 'Beds' The Tape In It
- Ergonomic Soft Grip Handle
- Flexible Stainless Steel Blades
- Metal End Cap For Protruding Nails

Jointing Knives



Part No	Type	Size	Handle	Pack Qty
SJ-718F	Jointing Knives	102mm	Soft Grip	5
SJ-719G	Jointing Knives	152mm	Soft Grip	5

- Ergonomic Soft Grip Handle with Specially Designed End Cap for Knocking Back Protruding Nails
- Flexible Stainless Steel Blades
- Metal End Cap for Protruding Nails

Plasterers Square



Part No	Type	Size	Material	Pack Qty
SJ-PLASQ	Plasterers Square	210mm	Stainless Steel	6

- Blade Size 210mm x 210mm
- Stainless Steel
- For Marking Plaster Sheet Prior To Cutting

BUILDERS' TOOLS

cement tools



Designed for professionals and DIY users alike, this range of concreting tools has been built to the same exacting standards of all Spear & Jackson products.

A range of floats and accessories produced using innovative manufacturing techniques to give durable, well finished product that can be used every day.

Pointed Nose For Finishing Corners & Edges

Ergonomic Soft Grip Off Set Handle Provides Superior Comfort & Control

Laser Etched Blade

Carbon Steel Blade for Extra Strength & Durability

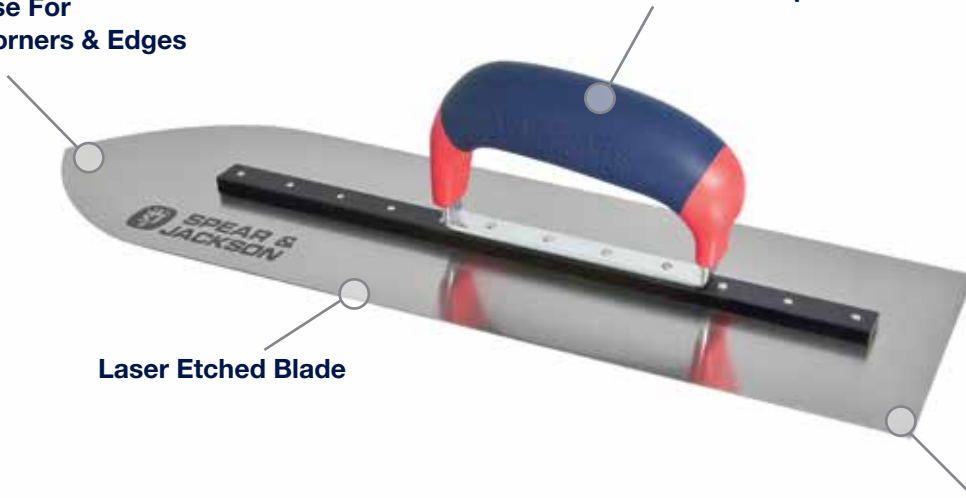

Finishing Float

Finishing Float

Pointed Finishing Float



Part No	Type	Size	Handle	Pack Qty
SJ-CF280	Finishing Float	280mm	Soft Grip	6
<ul style="list-style-type: none"> • Blade Size 280mm x 120mm x 0.70mm • Carbon Steel Blade • Ergonomic Soft Grip Off Set Handle • Laser Etched Blade 				

Part No	Type	Size	Handle	Pack Qty
SJ-CF405	Finishing Float	405mm	Soft Grip	6
<ul style="list-style-type: none"> • Blade Size 405mm x 115mm x 0.70mm • Carbon Steel Blade • Ergonomic Soft Grip Off Set Handle • Laser Etched Blade 				

Part No	Type	Size	Handle	Pack Qty
SJ-340	Pointed Finishing Float	400mm	Polypropylene	6
<ul style="list-style-type: none"> • Pointed Nose • Blade Size 400mm x 112mm x 0.64mm • Carbon Steel Blade • FSC Timber Offset Handle • Laser Etched Blade 				

BUILDERS' TOOLS

cement tools

Pointed Finishing Float

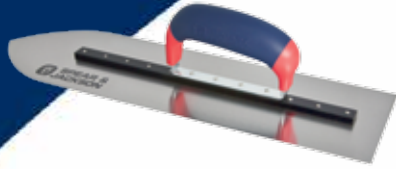

Part No	Type	Size	Handle	Pack Qty
SJ-PF355	Pointed Finishing Float	355mm	Soft Grip	6

- Pointed Nose
- Blade Size 355mm x 100mm x 0.70mm
- Carbon Steel Blade
- Ergonomic Soft Grip Offset Handle
- Laser Etched Blade

Pointed Finishing Float



Part No	Type	Size	Handle	Pack Qty
SJ-PF405	Pointed Finishing Float	405mm	Soft Grip	6

- Pointed Nose
- Blade Size 405mm x 115mm x 0.70mm
- Carbon Steel Blade
- Ergonomic Soft Grip Offset Handle
- Laser Etched Blade

Pointed Finishing Float



Part No	Type	Size	Handle	Pack Qty
SJ-PF450	Pointed Finishing Float	450mm	Soft Grip	6

- Pointed Nose
- Blade Size 450mm x 115mm x 0.70mm
- Carbon Steel Blade
- Ergonomic Soft Grip Offset Handle
- Laser Etched Blade

Pointed Finishing Float



Part No	Type	Size	Handle	Pack Qty
SJ-PF500	Pointed Finishing Float	500mm	Soft Grip	6

- Pointed Nose
- Blade Size 500mm x 115mm x 0.70mm
- Carbon Steel Blade
- Ergonomic Soft Grip Offset Handle
- Laser Etched Blade

Pointed Finishing Float



Part No	Type	Size	Handle	Pack Qty
SJ-PF600	Pointed Finishing Float	600mm	Soft Grip	6

- Pointed Nose
- Blade Size 600mm x 115mm x 0.70mm
- Carbon Steel Blade
- Ergonomic Soft Grip Offset Handle
- Laser Etched Blade

Cement Edger

Timber Handle



Part No	Type	Size	Handle	Pack Qty
SJ-348	Cement Edger	150mm	Timber	6

- Blade Size 150mm x 75mm x 1.25mm
- 10.8mm Radius
- Stainless Steel Blade
- Timber Handle
- Laser Etched Blade

Cement Edger

Soft Grip Handle



Part No	Type	Size	Handle	Pack Qty
SJ-540	Cement Edger	150mm	Soft Grip	6

- Blade Size 150mm x 75mm x 1.25mm
- 10.8mm Radius
- Stainless Steel Blade
- Ergonomic Soft Grip Handle
- Laser Etched Blade

Cement Groover

Timber Handle



Part No	Type	Size	Handle	Pack Qty
SJ-345	Cement Groover	155mm	Timber	6

- Blade Size 155mm x 76mm x 1.27mm
- Groove Depth 9mm
- Stainless Steel Blade
- Timber Handle
- Laser Etched Blade

Cement Groover

Soft Grip Handle



Part No	Type	Size	Handle	Pack Qty
SJ-541	Cement Groover	155mm	Soft Grip	6

- Blade Size 155mm x 76mm x 1.27mm
- Groove Depth 9mm
- Stainless Steel Blade
- Ergonomic Soft Grip Handle
- Laser Etched Blade

BUILDERS' TOOLS

cement tools

Hardwood Float



Part No	Type	Size	Handle	Pack Qty
SJ-210SF	Hardwood Float	365mm	Plastic	6

- Kiln Dried Hardwood Blade
- Base Size 365mm x 112mm x 20mm
- Comfortable Plastic Handle
- Engraved Logo

Hardwood Float



Part No	Type	Size	Handle	Pack Qty
SJ-220SF	Hardwood Float	450mm	Plastic	6

- Kiln Dried Hardwood Blade
- Base Size 450mm x 112mm x 20mm
- Comfortable Plastic Handle
- Engraved Logo

Hardwood Float



Part No	Type	Size	Handle	Pack Qty
SJ-230SF	Hardwood Float	465mm	Plastic	12

- Kiln Dried Hardwood Blade
- Base Size 465mm x 50mm x 20mm
- Comfortable Plastic Handle
- Engraved Logo

Pine Float



Part No	Type	Size	Handle	Pack Qty
SJ-50102	Pine Float	270mm	Plastic	10

- Pine Timber Blade
- Base Size 270mm x 95mm x 20mm
- Comfortable Plastic Handle
- Engraved Logo

Pine Float



Part No	Type	Size	Handle	Pack Qty
SJ-50103	Pine Float	375mm	Plastic	8

- Pine Timber Blade
- Base Size 375mm x 115mm x 20mm
- Comfortable Plastic Handle
- Engraved Logo

Pine Float



Part No	Type	Size	Handle	Pack Qty
SJ-50104	Pine Float	605mm	Plastic	6

- Pine Timber Blade
- Base Size 605mm x 115mm x 20mm
- Comfortable Plastic Handle
- Engraved Logo

Magnesium Float



Part No	Type	Size	Handle	Pack Qty
SJ-MF410	Magnesium Float	410mm	Plastic	6

- Blade Size 410mm x 80mm x 6-8mm
- Lightweight Magnesium Alloy Blade
- Off Set Handle
- Comfortable Plastic Handle

Magnesium Float



Part No	Type	Size	Handle	Pack Qty
SJ-MF510	Magnesium Float	510mm	Plastic	6

- Blade Size 510mm x 80mm x 6-8mm
- Lightweight Magnesium Alloy Blade
- Off Set Handle
- Comfortable Plastic Handle

Cement Sheet Cutter



Part No	Type	Cutting Depth	Handle	Pack Qty
SJ-FCC	Cement Sheet Cutter	10mm	Soft Grip	10

- Blade Length 80mm
- Cutting Depth 10mm
- Carbon Steel Head
- Strong Tubular Steel Handles
- Ergonomic Soft Grip Handles

BUILDERS' TOOLS

cement tools

Kneeler Board



Part No	Type	Size	Handle	Pack Qty
SJ-KB	Kneeler Board	350mm x 480mm	Plastic	12

- Kneeler Board for Concreters
- One Piece Poly Tray with Handles
- Memory Foam for Maximum Comfort
- Used for Kneeling on Concrete Pads When Doing Finishing Work.



Concrete Rake



Part No	Type	Blade Size	Handle	Pack Qty
SJ-CPR	Concrete Rake	500m x 100mm	Aluminium	6

- Aluminium Head Shaped for Use
- Aluminium Handle for Balance of Weight and Strength
- Strong Aluminium Stays for Extra Support
- Designed For Shifting Wet Concrete Prior To Finishing
- Handle Length 1500mm

Straight Edges



Easy to Clean Red Powder Coat Finish

Part No	Type	Size	Pack Qty
SJ-SE12	Aluminium Straight Edge	1200mm	4
SJ-SE15	Aluminium Straight Edge	1500mm	4
SJ-SE18	Aluminium Straight Edge	1800mm	4
SJ-SE21	Aluminium Straight Edge	2100mm	4
SJ-SE24	Aluminium Straight Edge	2400mm	4
SJ-SE27	Aluminium Straight Edge	2700mm	4
SJ-SE30	Aluminium Straight Edge	3000mm	4
SJ-SE36	Aluminium Straight Edge	3600mm	4

- 20 X 70mm Profile
- Fluted Profile - Easy to Grip Extrusion Design
- High Quality Extruded Aluminium
- Easy to Clean Powder-Coated Finish

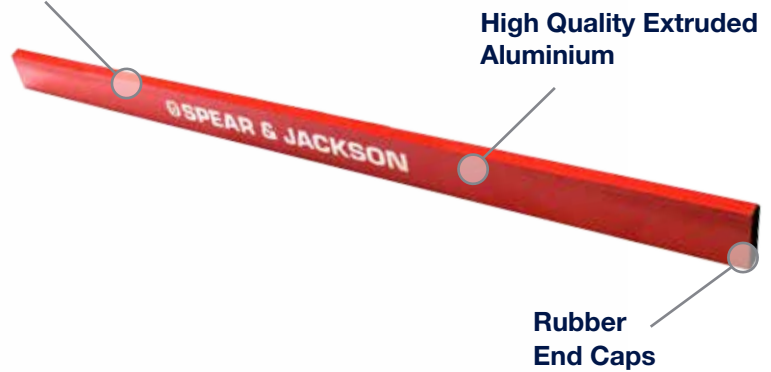

High Quality Extruded Aluminium

Rubber End Caps

Screeds



Ergonomic Aluminium Grip Handle

Part No	Type	Size	Pack Qty
SJ-SC12	Aluminium Concrete Screed	1200mm	4
SJ-SC15	Aluminium Concrete Screed	1500mm	4
SJ-SC18	Aluminium Concrete Screed	1800mm	4
SJ-SC21	Aluminium Concrete Screed	2100mm	4
SJ-SC24	Aluminium Concrete Screed	2400mm	4
SJ-SC27	Aluminium Concrete Screed	2700mm	4
SJ-SC30	Aluminium Concrete Screed	3000mm	4
SJ-SC36	Aluminium Concrete Screed	3600mm	4

- Heavy Duty Structural Alloy
- Reversible Clamped Handle
- Ergonomic Grip Handle
- Easy To Clean Powder-Coated Finish
- Cutting and Pushing Edge Positioned for Comfort
- Profile Size 40 X 50mm



Heavy Duty Structural Alloy

Strong Metal Clamps

Replacement Screed Handle with Vial



Part No	Type	Length	Handle	Pack Qty
SJ-SHV	Screed Vial Handle	900m x 35mm	Aluminium	6

- 900mm Aluminium Handle with Vial
- Designed to Ensure a Straight and Level Finish

BUILDERS' TOOLS

cement tools

Designed for professionals and DIY users alike the Spear & Jackson Hopper Gun is ideal for initial coats of concrete floors, cinder block walls, stucco ceilings and exterior walls.

Capable of using heavy texture materials the Spear & Jackson Hopper Gun is lightweight and easy to use. Spare Parts available below.

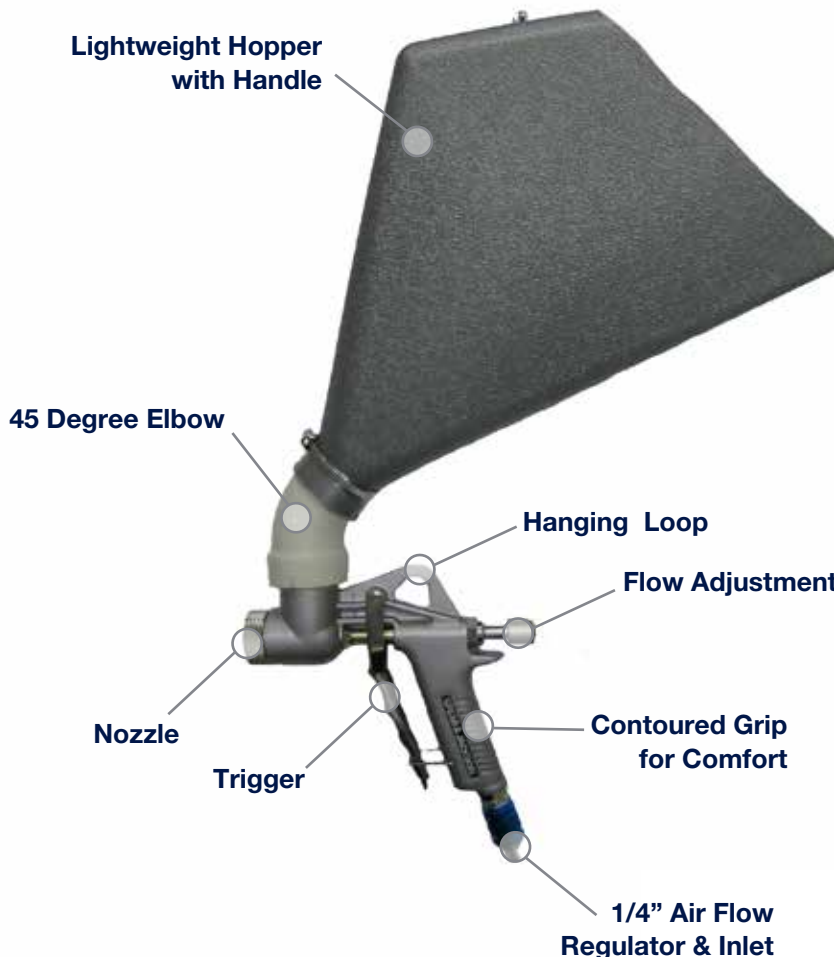

Part No.	Description
----------	-------------

SJ-FR301-04	6mm nozzle
SJ-FR301-03	4mm nozzle
SJ-FR3108A	O Ring
SJ-FR3102A	Retaining Ring
SJ-FR301-05	8mm Nozzle
SJ-FR3121A	O Ring 36mm x 42mm x 3mm
SJ-FR3115A	O Ring
SJ-FR3111A	O Ring
SJ-3120	Connector
SJ-3130	Elbow
SJ-FR3107A	Fitting
SJ-FR3116A	Spring
SJ-FR3109A	Needle Shaft
SJ-FR3112	Regulator Guide
SJ-FR3129	Plastic Hopper
SJ-RP166P18	Repair Kit
SJ-HG4001-K1	Repair Kit

Hopper Gun

Lightweight Plastic



Part No	Type	Nozzle Size	Pack Qty
SJ-HG401	Hopper Gun	3mm	4

- Lightweight Plastic Hopper with Grip
- 45 Degree Elbow to Prevent Spillage
- Adjustable Nozzle
- Contoured Comfort Trigger
- Hanging Hoop
- Material Flow Adjustment
- Air Regulator

Hoe - Mortar

Long Timber Handle



Part No	Type	Head Size	Pack Qty
SJ-MH1	Mortar Hoe	420mm x 200mm	6

- Ideal For Quick Mixing Of Brick, Plaster, Mortar & Small Quantities Of Concrete
- Powder Coated Carbon Steel Head
- Long Timber Shaft
- FSC Certified Timber

Square Mouth

All Steel D-Handle



Part No	Type	Head Size	Pack Qty
SJ-WS350	Square Mouth	300mm x 255mm	6

- Ideal For Shovelling / Mixing Soils, Sand & Concrete
- All Steel Construction
- Extra Long 30" Handle for Extra Reach
- All Metal D-Handle

Square Mouth

All Steel Long Handle



Part No	Type	Head Size	Pack Qty
SJ-WS360L	Square Mouth	300mm x 255mm	6

- Ideal For Shovelling / Mixing Soils, Sand & Concrete
- All Steel Construction
- Long Handle with Soft Grip End Cap
- Overall Length 1240mm

BUILDERS' TOOLS

tiling tools



Designed for professionals and DIY users alike, this range of Tiling Tools has been built to the same exacting standards of all Spear & Jackson products.

A range of floats and accessories produced using innovative manufacturing techniques to give durable, well finished product that can be used every day by the professional and home handyman alike.

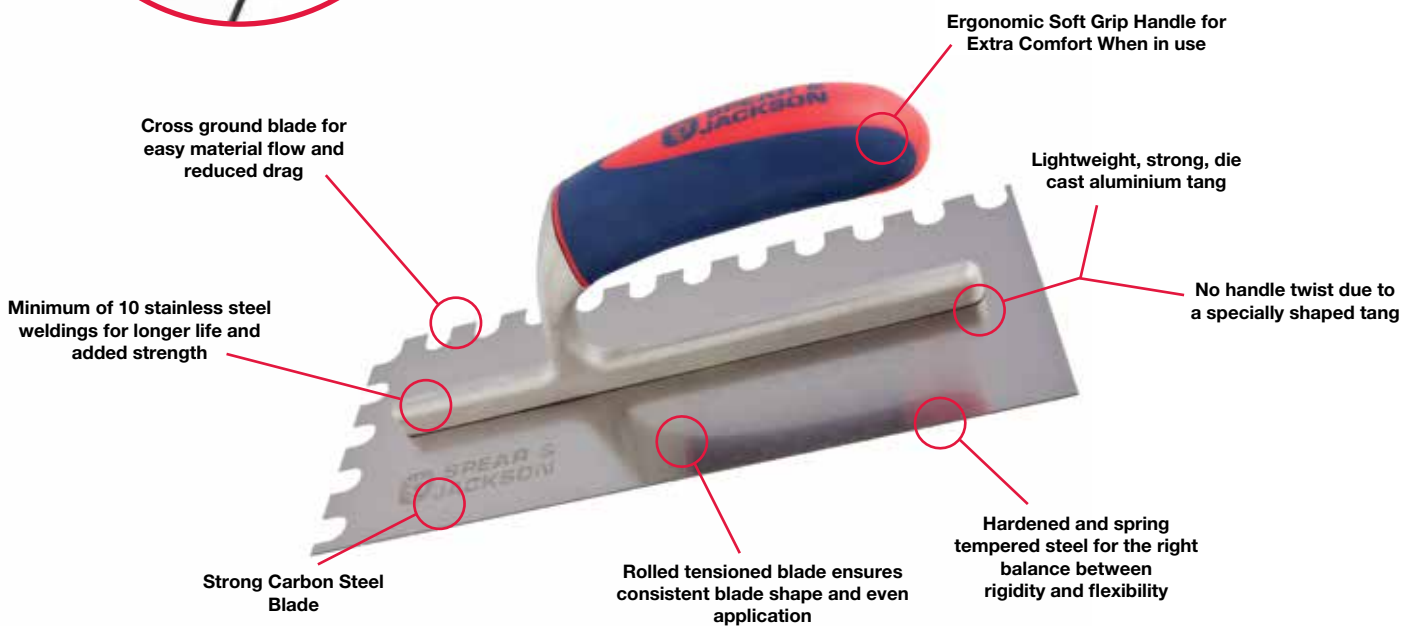

Notched Float



Part No	Type	Notch Size	Handle	Pack Qty
SJ-585	Notched Float	6mm	Soft Grip	6
SJ-585/8	Notched Float	8mm	Soft Grip	6
SJ-585/10	Notched Float	10mm	Soft Grip	6
SJ-585/12	Notched Float	12mm	Soft Grip	6

- Blade Size 280mm x 113mm
- Carbon Steel
- Aluminium Tang
- Ergonomic Soft Grip Handle

Adhesive Spreader

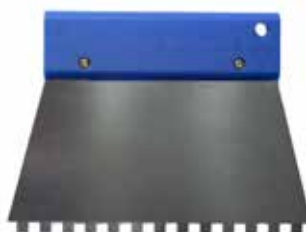

Part No	Type	Notch Size	Handle	Pack Qty
EM-TC0113	Adhesive Spreader	6mm	Plastic	24
EM-TC0112	Adhesive Spreader	8mm	Plastic	24
EM-TC0111	Adhesive Spreader	10mm	Plastic	24

- Blade Size 160mm x 110mm x 0.43mm
- Comfortable Plastic Handle

Adhesive Spreader



Part No	Type	Notch Sizes	Material	Pack Qty
EM-TC0516	Adhesive Spreader	3mm, 5mm, 6mm & 10mm	Plastic	48

- Blade Size 180mm x 140mm x 1.81mm
- Multiple Notch Sizes
- Easy to Use
- Durable Plastic Construction

BUILDERS' TOOLS

tiling tools

Grouting Float



Part No	Type	Blade Size	Handle	Pack Qty
EM-TC0120	Grouting Float	270mm x 80mm x 15mm	Plastic	12

- One Piece Plastic Handle & Body
- Pointed Tip for doing Corners
- Foam Pad

Grout Spreader



Part No	Type	Blade Size	Handle	Pack Qty
EM-TC0115	Grout Spreader	200mm x 40mm x 17mm	Timber	12
EM-TC0114	Grout Spreader	300mm x 40mm x 17mm	Timber	12

- Rubber Blade
- Timber Handle
- Handle Size EM-TC0115 200mm x 45mm x 17mm
- Handle Size EM-TC0114 300mm x 45mm x 17mm

Grout Remover



Part No	Type	Handle Size	Handle	Pack Qty
EM-TC0515A	Grout Remover	190mm x 25mm x 20mm	Plastic	12

- Total Length 215mm
- Carbide Coated Blade
- Ergonomic Plastic Handle

Glass Cutter

Plastic Body



Part No	Type	Material	Pack Qty
EM-TC0346	Glass Cutter	Clear Plastic	6

- Clear Plastic Body
- Oil Lubricated
- Tungsten Carbide Cutting Wheel
- Glass Breaker End

Glass Cutter

Metal Body



Part No	Type	Material	Pack Qty
EM-TC0347	Glass Cutter	Metal	12

- One Piece Metal Construction
- Tungsten Carbide Cutting Wheel
- Glass Breaker End

Scoring Cutter

Soft Grip Handle



Part No	Type	Handle	Pack Qty
EM-TC0331	Scoring Cutter	Plastic	12

- Tungsten Carbide Tipped
- Ergonomic Plastic Handle
- Blade Angled for Ease of Use

Tile Cutter

Metal Body



Part No	Type	Material	Pack Qty
EM-TC0345	Tile Cutter	Metal	12

- Two Piece Metal Body
- Tungsten Carbide Tipped as One End
- Tile Breaker

Circular Tile Cutter



Part No	Type	Cutting Diameter	Pack Qty
EM-TC0307	Circular Tile Cutter	20mm - 94mm	12

- Plastic Cage
- Cage Prevents Spread of Chips
- Suitable for Cutting Large Diameter Circular Holes
- Fits to Power Drill

Mechanical Tile Cutter



Part No	Type	Maximum Length Cut	Pack Qty
EM-TC0920	Mechanical Tile Cutter	400mm	6
EM-TCW1515T	Spare Cutting Wheel	n/a	20

- Tungsten Carbide Cutting Wheel
- Maximum Length of Cut 400mm
- Maximum Thickness of Cut 15mm

BUILDERS' TOOLS

tiling tools

Tile Piler



Part No	Type	Size	Pack Qty
EM-TC0103A	Tile Piler	200mm	12

- Carbon Steel Handles
- Tungsten Carbide Cutting Wheel
- Comfort Grip Handles

Tile Hole Cutter



Part No	Type	Size	Pack Qty
EM-TC0108	Tile Hole Cutter	200mm	12

- Drop Forged Carbon Steel Body
- For Cutting Holes in Tiles
- Comfort Grip Handles
- Hardened Head

Tile Nipper



Part No	Type	Size	Pack Qty
EM-TC0106	Tile Nipper	200mm	12

- Drop Forged Carbon Steel Body
- For Straight Cuts
- Comfort Grip Handles

Tile Borer



Part No	Type	Material	Pack Qty
EM-TC0306	Tile Borer	Metal	10

- Suitable for Cutting Small Diameter Circular Holes
- Fits to Power Drill

Tiling Sponge



Part No	Type	Size	Pack Qty
SJ-ST5	Tiling Sponge	220mm x 115mm x 70mm	6

- Peanut Shaped for Ease of Use
- Size 220mm x 115mm x 70mm

Contour Gauge



Part No	Type	Size	Pack Qty
EG-200CG	Contour Gauge	150mm	10

- Used to Duplicate Shapes and Form
- All Metal Construction
- Connecting Plate for Joining Additional Gauges

Caulking Gun

Half Barrel Frame



Part No	Type	Material	Size	Pack Qty
EG-220	Caulking Gun - Half Barrel Frame	Metal	220mm	36

- Half Barrel Frame
- Strong Contoured Trigger

Caulking Gun

Open Frame



Part No	Type	Material	Size	Pack Qty
EG-221	Caulking Gun - Open Frame	Metal	225mm	36

- Open Frame
- Hang Hook
- Strong Contoured Trigger

Caulking Gun

Premium - Half Barrel Frame



Part No	Type	Material	Size	Pack Qty
SJ-PCG	Caulking Gun - Premium	Metal	225mm	6

- Premium Quality
- Half Barrel Frame
- Hang Hook
- Strong Contoured Trigger

BUILDERS' TOOLS

tiling tools

Flexible Scraper



Part No	Type	Blade Size	Pack Qty
EG-665/01	Flexible Scraper	32mm	6
EG-665/02	Flexible Scraper	50mm	6
EG-665/03	Flexible Scraper	75mm	6
EG-665/04	Flexible Scraper	100mm	6
EG-665/06	Flexible Scraper	150mm	6

- Available in 32mm/50mm/75mm/100mm/150mm
- Carbon Steel Flexible Blade
- Plastic Handle
- For applying joint fillers, patching, scrapping jobs and trimming wall papers

Stiff Scraper



Part No	Type	Blade Size	Pack Qty
SJ-SK25	Stiff Scraper	25mm	6
SJ-SK50	Stiff Scraper	50mm	6
SJ-SK75	Stiff Scraper	75mm	6
SJ-SK100	Stiff Scraper	100mm	6

- Available in 25mm/50mm/75mm/100mm
- Stainless Steel Stiff Blade
- Rosewood Timber Handle
- For applying joint fillers, patching, scrapping jobs and trimming wall papers

Spacer Plastic



Part No	Type	Size	Pack Qty
SJ-T808015	Plastic Spacer - Wedge	1-5mm	12

- Wedge Shape 1-5mm
- 250 Pieces per Pack
- One Piece Moulded Plastic
- Hardened for Extra Strength

Spacer Plastic



Part No	Type	Size	Pack Qty
SJ-T80803T	Plastic Spacer - T Shape	3mm	24

- T Shape 3mm
- 250 Pieces per Pack
- One Piece Moulded Plastic
- Hardened for Extra Strength

Putty Knife



Part No	Type	Blade Size	Pack Qty
EG-665P	Putty Knife	50mm	6

- Carbon Steel Polished Handle
- Shaped Plastic Handle
- Used to Work Putty Around the Edges of Glass Panes

Spacer Plastic



Part No	Type	Size	Pack Qty
EM-TC0511	Plastic Spacer - Cross Shape	2mm	12
EM-TC0512	Plastic Spacer - Cross Shape	3mm	12
EM-TC0513	Plastic Spacer - Cross Shape	4mm	12
EM-TC0514	Plastic Spacer - Cross Shape	5mm	12

- Cross Shape 2mm, 3mm, 4mm, 5mm
- 250 Pieces per Pack
- One Piece Moulded Plastic
- Hardened for Extra Strength

Floor Scrapers



Part No	Type	Blade Size	Handle	Pack Qty
SJ-FS200	Floor Scraper	200mm	Steel T-Frame	3
SJ-FS300	Floor Scraper	300mm	Steel T-Frame	3
SJ-FS356	Floor Scraper	356mm	Steel T-Frame	3
SJ-FS356T	Floor Scraper	356mm	Timber	3
SJ-FS500	Floor Scraper	500mm	Steel T-Frame	3

- Available in 200mm/300mm/356mm/500mm
- Replaceable Carbon Steel Blade
- Strong Steel Blade Holder with Butterfly Nuts



Tubular Steel T-Frame Handle to Prevent Bending or Breaking when in use
Available with 200mm / 300mm / 365mm & 500mm Blades

Spare Scraper Blades



Part No	Type	Blade Size	Pack Qty
SJ-FS200B	Floor Scraper Blade	200mm	10
SJ-FS300B	Floor Scraper Blade	300mm	10
SJ-FS356B	Floor Scraper Blade	356mm	10
SJ-FS500B	Floor Scraper Blade	500mm	10

- Available in 200mm/300mm/356mm/500mm
- Blade to suit Floor Scraper

RAGNI

tools

PLASTERING TOOLS
CONCRETING TOOLS
RENDERING TOOLS
TILING TOOLS

Since 1962 RAGNI proudly delivers unbeatable value for money to professional trademans around the world. All products are protected with a thin layer of transparent lacquer to prevent rust. The ergonomic handle shapes offer optimal comfort to professional users, the unique design maximizes grip, never slips or twists on its tang.

The complete Ragni range offers first class products at very competitive pricing.



Ragni Handle Types



Easi-Grip - The BI-Material Easi-Grip handle is ergonomically designed for the most comfortable feel. The technopolymer coating reduces wrist strain during prolonged use by filtering blade vibrations. Research indicates the Ragni Easi-Grip is preferred by professional plasterers.



Super Lite - Thanks to its ABS handle, the Super Lite Ragni Floats are more than 40% lighter than traditional floats but assures up to 80% of their strength. The increase flexibility and lightweight make it the optimal choice for DIY applications.



Standard ABS - The Standard ABS handle is designed to cater both the professional and DIY user. The one piece plastic handle is very durable and features finger grips to prevent slipping. Its ergonomic design and lightweight make it a perfect choice for any professional or DIY application.

Plastering Float



Part No	Type	Blade Type	Handle	Pack Qty
RA-230	Plastering Float	Carbon Steel	Super Lite	6

- Carbon Steel Lightweight Blade
- Blade Size 280mm x 120mm x 0.60mm
- Ergonomic Offset Superlite Handle
- Laser Etched Blade

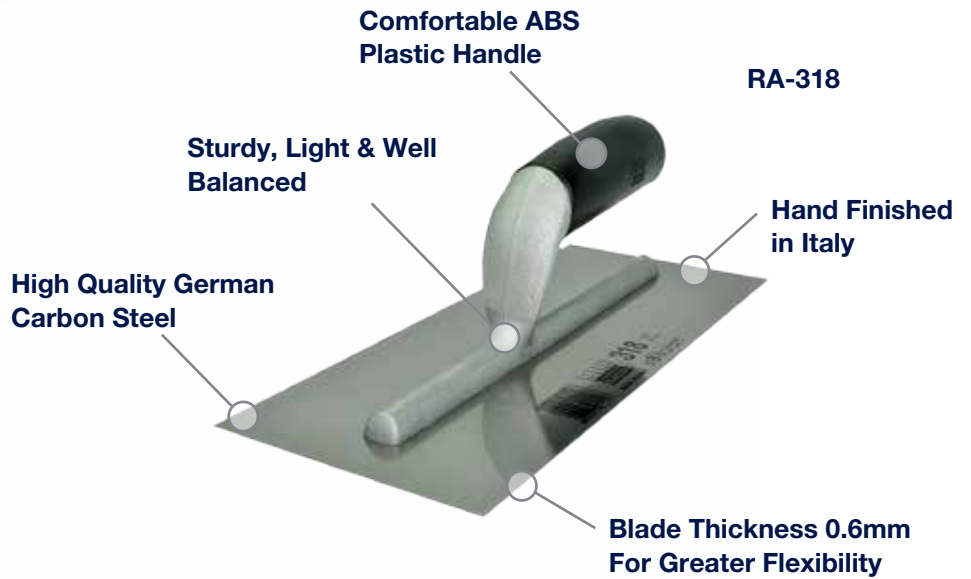

RA-318

Plastering Float



Part No	Type	Blade Type	Handle	Pack Qty
RA-318	Plastering Float	Carbon Steel	ABS	6

- Carbon Steel Lightweight Blade
- Blade Size 280mm x 120mm x 0.60mm
- High Quality ABS Handle
- Laser Etched Blade

Plastering Float



Part No	Type	Blade Type	Handle	Pack Qty
RA-318S	Plastering Float	Stainless Steel	ABS	6

- Stainless Steel Lightweight Blade
- Blade Size 280mm x 120mm x 0.60mm
- Ergonomic Offset Superlite Handle
- Laser Etched Blade

Plastering Float



Part No	Type	Blade Type	Handle	Pack Qty
RA-318C	Plastering Float	Curved Carbon Steel	ABS	6

- Curved Carbon Steel Blade
- Blade Size 280mm x 120mm x 0.60mm
- High Quality ABS Handle
- Laser Etched Blade

Plastering Float



Part No	Type	Blade Type	Handle	Pack Qty
RA-418	Plastering Float	Carbon Steel	Easi-Grip	6

- Carbon Steel Lightweight Blade
- Blade Size 280mm x 120mm x 0.60mm
- Ergonomic Soft Grip Handle
- Laser Etched Blade

Plastering Float



Part No	Type	Blade Type	Handle	Pack Qty
RA-418S	Plastering Float	Stainless Steel	Easi-Grip	6

- Stainless Steel Lightweight Blade
- Blade Size 280mm x 120mm x 0.60mm
- Ergonomic Soft Grip Handle
- Laser Etched Blade

Plastering Float



Part No	Type	Blade Type	Handle	Pack Qty
RA-418L	Plastering Float	Stainless Steel	Easi-Grip	6

- Stainless Steel Lightweight Blade
- Blade Size 360mm x 120mm x 0.60mm
- Ergonomic Soft Grip Handle
- Laser Etched Blade

Notched Float



Part No	Type	Blade Type	Handle	Pack Qty
RA-231	Notched Float	Carbon Steel	Super Lite	6

- Blade Size 280mm x 120mm x 0.60mm
- Notch Size 4.44mm x 8.25mm
- Handle Bonded to Blade
- Ergonomic Offset Superlite Handle
- Laser Etched Blade

Splatter Gun



Part No	Type	Body Material	Handle	Pack Qty
RA-SG	Splatter Gun	Metal	Plastic	12

- Used for Rendering And Stipple Finishes
- Replacement Combs Available Separately
- Steel Body
- Ergonomic Plastic Handles

Plasterers Hawk



Part No	Type	Blade Type	Handle	Pack Qty
RA-900	Plasterers Hawk	Aluminium	Easi-Grip	3

- Aluminium Blade
- Blade Size 300mm x 300mm
- Ergonomic Soft Grip Handle

Easi-Grip Handle for Extra Comfort

High Gauge, Hardened & Tempered Aluminum

Hand Finished in Italy

Rounded Corners for a Smooth Clean Finish

Heavily Scarred Surface Helps Holding Plaster

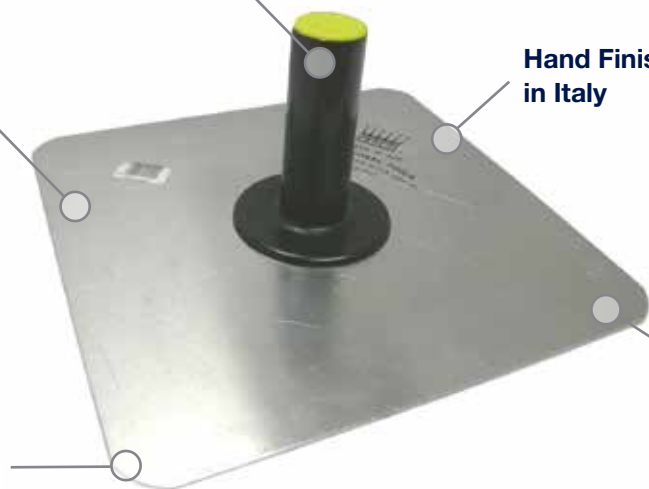

Concreting Float



Part No	Type	Blade Type	Handle	Pack Qty
RA-325	Concrete Float	Carbon Steel	ABS	6

- Carbon Steel Blade
- Finishing Float
- Blade Size 360mm x 100mm x 0.86mm
- High Quality ABS Handle
- Laser Etched Blade

Concreting Float



Part No	Type	Blade Type	Handle	Pack Qty
RA-425	Concreting Float	Carbon Steel	Easi-Grip	6

- Finishing Float
- Carbon Steel Blade
- Blade Size 360mm x 100mm x 0.86mm
- Ergonomic Soft Grip Handle
- Laser Etched Blade

Rendering Float



Part No	Type	Blade Type	Handle	Pack Qty
RA-320	Rendering Float	Plastic	Super Lite	6

- Rendering Float
- Plastic Blade 3mm thick
- Blade Size 280mm x 120mm
- Ergonomic Offset Superlite Handle
- Laser Etched Blade

TRULINE builders tools

Since 1947 Harvie Morris Pty Ltd - an Australian family business have produced and sold thousands of plastering and cementing tools in Australia and overseas.

All Truline premium trowels (except stainless) are manufactured from a superior grade manganese alloy steel formulated for high tensile strength, flexibility and long life.



Shanks - are made from a silicon magnesium aluminium alloy scientifically heat treated to exacting specifications to provide a tensile strength of 10 tons per square inch. This is the lightest, most rigid yet resilient shank, ever produced for a plasterers' trowel.



Handles - have been designed with on the job Tradesmen to a comfortable banana shape and made with a soft grip moulding and securely held with a non-rusting adjusting nut.



Blades - are made from hardened and tempered tungsten chrome alloy steel, produced to our own specifications by Sheffield's largest steelmaker. Blades are hand riveted and ground and every trowel is individually tested for trueness and finish.

Plastering Float 200mm



Part No	Type	Blade Type	Pack Qty
TR-CA200	Plastering Float	Spring Steel	5

- Lightweight Spring Steel Blade
- Designed for General Purpose Use
- Blade Size 200mm x 117mm x 0.71mm
- Magnesium Alloy Cast Tang
- Plastic Handle

Plastering Float 200mm



Part No	Type	Blade Type	Pack Qty
TA-CB200	Plastering Float	Spring Steel	5

- Extra Lightweight Spring Steel Blade
- Lightweight & Flexible For A Fine Finish
- Blade Size 200mm x 117mm x 0.46mm
- Magnesium Alloy Cast Tang
- Plastic Handle

Plastering Float 200mm



Part No	Type	Blade Type	Pack Qty
TR-CC200	Plastering Float	Spring Steel	5

- Lightweight Spring Steel Blade
- Curved Blade Designed for Wallboard Jointing
- Blade Size 200mm x 117mm x 0.71mm
- Magnesium Alloy Cast Tang
- Plastic Handle

Plastering Float 200mm



Part No	Type	Blade Type	Pack Qty
TR-CF200	Plastering Float	Spring Steel	5

- Lightweight Spring Steel Blade
- Bowed Blade Designed for Wallboard Jointing
- Blade Size 200mm x 117mm x 0.71mm
- Magnesium Alloy Cast Tang
- Plastic Handle

TRULINE plastering tools



Plastering Float - 200mm



Part No	Type	Blade Type	Handle	Pack Qty
TR-CG200	Plastering Float	Stainless Steel	Plastic	5

- Rust Resistant Stainless Steel Blade
- Designed for Plastering & Wallboard Jointing
- Blade Size 200mm x 117mm x 0.61mm
- Magnesium Alloy Cast Tang
- Plastic Handle

Plastering Float - 200mm



SPECIAL ORDER ONLY

Part No	Type	Blade Type	Handle	Pack Qty
TR-CGC200	Plastering Float	Stainless Steel	Plastic	5

- Rust Resistant Stainless Steel Blade
- Curved Blade Designed for Plastering & Wallboard Jointing
- Blade Size 200mm x 117mm x 0.61mm
- Magnesium Alloy Cast Tang
- Plastic Handle

Sponge Float



Part No	Type	Blade Type	Handle	Pack Qty
TR-TK280	Sponge Float	Sponge	Plastic	25

- Tempered Masonite Hardboard Backing
- Blade Size 265mm x 115mm x 17mm
- Plastic Handle

Replacement Sponge

Available for TR-TK280

Part No	Pack Qty
TR-TK001	50



Plastering Float - 280mm



Part No	Type	Blade Type	Handle	Pack Qty
TR-CA280	Plastering Float	Spring Steel	Plastic	5

- Lightweight Spring Steel Blade
- Designed for General Purpose Use
- Blade Size 280mm x 117mm x 0.71mm
- Magnesium Alloy Cast Tang
- Plastic Handle

Plastering Float - 280mm



Part No	Type	Blade Type	Handle	Pack Qty
TR-CB280	Plastering Float	Spring Steel	Plastic	5

- Extra Lightweight Spring Steel Blade
- Extra Lightweight & Flexible For A Fine Finish
- Blade Size 280mm x 117mm x 0.46mm
- Magnesium Alloy Cast Tang
- Plastic Handle

Plastering Float - 280mm



Part No	Type	Blade Type	Handle	Pack Qty
TR-CC280	Plastering Float	Spring Steel	Plastic	5

- Lightweight Spring Steel Blade
- Curved Blade Designed for Wallboard Jointing
- Blade Size 280mm x 117mm x 0.71mm
- Magnesium Alloy Cast Tang
- Plastic Handle

Plastering Float - 280mm



SPECIAL ORDER ONLY

Part No	Type	Blade Type	Handle	Pack Qty
TR-CD280	Plastering Float	Alloy Steel	Plastic	5

- Heavy Duty Spring Steel Blade
- Durable Designed for Longer Life
- Blade Size 280mm x 117mm x 0.81mm
- Magnesium Alloy Cast Tang
- Plastic Handle

Plastering Float - 280mm



Part No	Type	Blade Type	Handle	Pack Qty
TR-CF280	Plastering Float	Spring Steel	Plastic	5

- Lightweight Spring Steel Blade
- Bowed Blade Designed for Wallboard Jointing
- Blade Size 280mm x 117mm x 0.71mm
- Magnesium Alloy Cast Tang
- Plastic Handle

Plastering Float - 280mm



Part No	Type	Blade Type	Handle	Pack Qty
TR-CG280	Plastering Float	Stainless Steel	Plastic	5

- Rust Resistant Stainless Steel Blade
- Designed for Plastering & Wallboard Jointing
- Blade Size 280mm x 117mm x 0.61mm
- Magnesium Alloy Cast Tang
- Plastic Handle

TRULINE plastering tools



Plastering Float - 280mm



SPECIAL ORDER ONLY

Part No	Type	Blade Type	Handle	Pack Qty
TR-CGC280	Plastering Float	Stainless Steel	Plastic	5

- Rust Resistant Stainless Steel Blade
- Curved Blade Designed for Plastering & Wallboard Jointing
- Blade Size 280mm x 117mm x 0.61mm
- Magnesium Alloy Cast Tang
- Plastic Handle

Plastering Float - 280mm



Part No	Type	Blade Type	Handle	Pack Qty
TR-PP129	Plastering Float	Spring Steel	Soft Grip	5

- Lightweight Spring Steel Blade
- Designed for General Purpose Use
- Blade Size 280mm x 117mm x 0.71mm
- Magnesium Alloy Cast Tang
- Soft Grip Handle

Plastering Float - 280mm



Part No	Type	Blade Type	Handle	Pack Qty
TR-PP139	Plastering Float	Spring Steel	Soft Grip	5

- High Grade Spring Steel Blade
- Extra Lightweight & Flexible For A Fine Finish
- Blade Size 280mm x 117mm x 0.46mm
- Magnesium Alloy Cast Tang
- Soft Grip Handle

Plastering Float - 355mm



Part No	Type	Blade Type	Handle	Pack Qty
TR-CA355	Plastering Float	Spring Steel	Soft Grip	5

- Lightweight Spring Steel Blade
- Designed for General Purpose Use
- Blade Size 355mm x 100mm x 0.71mm
- Magnesium Alloy Cast Tang
- Soft Grip Handle

Plastering Float - 355mm



Part No	Type	Blade Type	Handle	Pack Qty
TR-CG355	Plastering Float	Stainless Steel	Soft Grip	5

- Rust Resistant Stainless Steel Blade
- Designed for Plastering & Wallboard Jointing
- Blade Size 355mm x 117mm x 0.61mm
- Magnesium Alloy Cast Tang
- Soft Grip Handle

Plasterers Hawk



Part No	Type	Blade Type	Handle	Pack Qty
TR-TM305	Plasterers Hawk	Aluminium	Timber	5

- Lightweight
- Hardened Aluminium
- Blade Size 300mm x 300mm
- Timber Handle

Plastering Float - 355mm



Part No	Type	Blade Type	Handle	Pack Qty
TR-PP169	Plastering Float	Spring Steel	Soft Grip	5

- Lightweight Spring Steel Blade
- Designed for General Purpose Use
- Blade Size 355mm x 117mm x 0.71mm
- Magnesium Alloy Cast Tang
- Soft Grip Handle

Plastering Float - 355mm



Part No	Type	Blade Type	Handle	Pack Qty
TR-PP179	Plastering Float	Spring Steel	Soft Grip	5

- High Grade Spring Steel Blade
- Extra Lightweight & Flexible For A Fine Finish
- Blade Size 355mm x 117mm x 0.46mm
- Magnesium Alloy Cast Tang
- Soft Grip Handle

Plastering Float - 355mm



Part No	Type	Blade Type	Handle	Pack Qty
TR-PP189	Plastering Float	Stainless Steel	Soft Grip	5

- Rust Resistant Stainless Steel Blade
- Designed for Plastering & Wallboard Jointing
- Blade Size 355mm x 117mm x 0.61mm
- Magnesium Alloy Cast Tang
- Soft Grip Handle

SPECIAL ORDER ONLY

TRULINE plastering tools



External Corner Trowel



Part No	Type	Blade Type	Corner Radius	Pack Qty
TR-SS047	External Corner Trowel	Stainless Steel	5mm	5
TR-SS048	External Corner Trowel	Stainless Steel	8mm	5

- Stainless Steel Blade
- Blade Size 65mm x 25mm x 25mm
- Rounded Outer Edge
- Timber Handle

External Corner Trowel



Part No	Type	Blade Type	Corner Radius	Pack Qty
TR-SS049	External Corner Trowel	Stainless Steel	5mm	5

- Stainless Steel Blade
- Blade Size 65mm x 50mm x 50mm
- Rounded Outer Edge
- Timber Handle

External Corner Trowel



Part No	Type	Blade Type	Corner Radius	Pack Qty
TR-SS050	External Corner Trowel	Stainless Steel	8mm	5

- Stainless Steel Blade
- Blade Size 65mm x 50mm x 50mm
- Rounded Outer Edge
- Timber Handle

Internal Corner Trowel



SPECIAL ORDER ONLY

Part No	Type	Blade Type	Handle	Pack Qty
TR-TF001	Internal Corner Trowel	Carbon Steel	Timber	5

- High Carbon Steel Blade
- Blade Size 75mm x 55mm x 55mm
- Square Internal Corner Radius
- Square Outer Edge
- Timber Handle

Internal Corner Trowel



SPECIAL ORDER ONLY

Part No	Type	Blade Type	Corner Radius	Pack Qty
TR-TF005	Internal Corner Trowel	Carbon Steel	5mm	5
TR-TF008	Internal Corner Trowel	Carbon Steel	8mm	5

- High Carbon Steel Blade
- Blade Size 75mm x 55mm x 55mm
- Rounded Outer Edge
- Timber Handle

External Corner Trowel



SPECIAL ORDER ONLY

Part No	Type	Blade Type	Handle	Pack Qty
TR-TG001	External Corner Trowel	Carbon Steel	Timber	5

- High Carbon Steel Blade
- Blade Size 75mm x 55mm x 55mm
- Square External Corner Radius
- Square Outer Edge
- Timber Handle

External Corner Trowel



SPECIAL ORDER ONLY

Part No	Type	Blade Type	Corner Radius	Pack Qty
TR-TG005	External Corner Trowel	Carbon Steel	5mm	5

- High Carbon Steel Blade
- Blade Size 75mm x 55mm x 55mm
- 5mm Corner Radius
- Rounded Outer Edge
- Timber Handle

External Corner Trowel



SPECIAL ORDER ONLY

Part No	Type	Blade Type	Corner Radius	Pack Qty
TR-TG008	External Corner Trowel	Carbon Steel	8mm	5

- High Carbon Steel Blade
- Blade Size 75mm x 55mm x 55mm
- 8mm Corner Radius
- Rounded Outer Edge
- Timber Handle

External Corner Trowel



SPECIAL ORDER ONLY

Part No	Type	Blade Type	Corner Radius	Pack Qty
TR-TG013	External Corner Trowel	Carbon Steel	13mm	5

- High Carbon Steel Blade
- Blade Size 75mm x 55mm x 55mm
- 13mm Corner Radius
- Rounded Outer Edge
- Timber Handle

TRULINE concreting tools



Cement Groover



SPECIAL ORDER ONLY

Part No	Type	Blade Size	Blade Thickness	Pack Qty
TR-CIG1	Cement Groover	150mm x 75mm	4.7mm	5
TR-CIG2	Cement Groover	210mm x 75mm	6.7mm	5

- Cast Iron Blade
- Groove Depth TR-C1G1-(14mm), TR-C1G2-(19mm)
- Timber Handle

Cement Edger



Part No	Type	Blade Size	Depth	Pack Qty
TR-ER511**	Cement Edger	150mm x 60mm	13mm	5
TR-ER521**	Cement Edger	150mm x 60mm	25mm	5
TR-ER611	Cement Edger	150mm x 75mm	13mm	5
TR-ER621**	Cement Edger	150mm x 75mm	25mm	5

- Carbon Steel Blade
- Handle Diameter 22.86mm
- Radius 13mm
- Metal Handle

** SPECIAL ORDER ONLY

Cement Edger



SPECIAL ORDER ONLY

Part No	Type	Blade Size	Radius	Pack Qty
TR-SS005	Cement Edger	150mm x 75mm x 13mm	13mm	5
TR-SS006	Cement Edger	150mm x 95mm x 25mm	13mm	5

- Stainless Steel Blade
- Metal Handle

Cement Edger



Part No	Type	Blade Size	Depth	Pack Qty
TR-SC021	Cement Edger	150mm x 75mm x 1.7mm	13mm	5
TR-EL661	Cement Edger	150mm x 75mm x 13mm	75mm	5

- High Carbon Steel Blade
- Handle Diameter 22.86mm
- Metal Handle

** SPECIAL ORDER ONLY

Concreting Float 450mm



SPECIAL ORDER ONLY

Part No	Type	Blade Type	Handle	Pack Qty
TR-CA450	Concreting Float	Spring Steel	Plastic	5

- Lightweight Spring Steel Blade
- Designed for General Purpose Use
- Blade Size 450mm x 117mm x 0.71mm
- Magnesium Alloy Cast Tang
- Plastic Handle

TRULINE Concreting Tools

A range of floats and accessories produced using innovative manufacturing techniques to give durable, well finished product that can be used every day by the professional and home handyman alike.

Coving Tool External Corner



SPECIAL ORDER ONLY

Part No	Type	Blade Type	Depth	Pack Qty
TR-EC661	Coving Tool	Carbon Steel	75mm	5

- High Carbon Steel
- Blade Size 150mm x 75mm x 1.6mm
- 13mm External Radius
- Metal Handle

Floor Scraper



Part No	Type	Blade Size	Handle	Pack Qty
TR-FS150**	Floor Scraper	150mm x 117mm	Timber	5
TR-FS200	Floor Scraper	200mm x 117mm	Timber	5
TR-FS300	Floor Scraper	300mm x 117mm	Timber	5
TR-FS356	Floor Scraper	356mm x 117mm	Timber	3
TR-FS500	Floor Scraper	500mm x 117mm	Timber	3

- 150mm/200mm/300mm/356mm/ 500mm
- Spring Steel Blade
- Blade Width 117mm (W) x 22 Gauge (Thickness)
- Timber Handle 32 Diam x 1120mm Long Lacquered Meranti Batu

** SPECIAL ORDER ONLY

Floor Scraper Blades



SPECIAL ORDER ONLY

Part No	Type	Blade Size	Pack Qty
TR-BLSC20	Floor Scraper Blade	200mm x 117mm	10
TR-BLSC30	Floor Scraper Blade	300mm x 117mm	10
TR-BLSC356	Floor Scraper Blade	356mm x 117mm	10
TR-BLSC500	Floor Scraper Blade	500mm x 117mm	10

- 200mm/300mm/356mm/ 500mm
- To Suit TR-FS range
- Spring Steel Blade

SPECIAL ORDER ONLY

TRULINE brickwork tools



TRULINE Brickworking Tools

Through a combination of advanced technologies, optimum design and a commitment to quality, we are able to offer a comprehensive range of Plastering and Drywall tools for the Professional and DIY user alike.

Tuck Pointer



SPECIAL ORDER ONLY

Part No	Type	Blade Size	Handle	Pack Qty
TR-TE010	Tuck Pointer	90mm x 13.2mm	Timber	5

- Stainless Steel Blade
- Blade Thickness 2.07mm
- Timber Handle
- 10mm Diameter

Window Trowel



SPECIAL ORDER ONLY

Part No	Type	Blade Size	Pack Qty
TR-TD013	Window Trowel	120mm x 13mm	5
TR-TD019	Window Trowel	120mm x 19mm	5
TR-TD025	Window Trowel	120mm x 25mm	5

- Spring Steel Blade
- Timber Handle

Brick / Block Jointers



SPECIAL ORDER ONLY

Part No	Type	Blade Size	Pack Qty
TR-TS010	Brick Jointer	150mm x 10mm	10
TR-TU010	Block Jointer	350mm x 10mm	10
TR-TU013	Block Jointer	350mm x 13mm	10
TR-TU016	Block Jointer	350mm x 16mm	10

- Carbon Steel
- Profile: Round

Joint Raker



SPECIAL ORDER ONLY

Part No	Type	Wheel Diameter	Material	Pack Qty
TR-TR001	Roller Raker	38.5mm	Plastic	20

- Moulded Plastic
- Wheel Diameter 38.5mm
- Adjustable Nail Height

Splash Trowel



SPECIAL ORDER ONLY

Part No	Type	Blade Size	Handle	Pack Qty
TR-TH150	Splash Trowel	150mm x 100mm x 1.6mm	Timber	5

- Spring Steel Blade
- Timber Handle

Margin Trowel



SPECIAL ORDER ONLY

Part No	Type	Blade Size	Handle	Pack Qty
TR-TC065	Margin Trowel	120mm x 65mm x 1.1mm	Timber	5

- Spring Steel Blade
- Timber Handle

Moulders Trowel



SPECIAL ORDER ONLY

Part No	Type	Blade Size	Handle	Pack Qty
TR-MT712	Moulders Trowel	175mm x 35mm x 1.18mm	Timber	5

- Tapered Spring Steel Blade
- Timber Handle

Cabinet Scrapers



SPECIAL ORDER ONLY

Part No	Type	Blade Size	Pack Qty
TR-TW125	Cabinet Scraper	125mm x 75mm	25
TR-TW150	Cabinet Scraper	150mm x 75mm	25

- Spring Steel Blade
- Designed for Woodworking, Shaping & Finishing



SPEAR & JACKSON

AIR TOOLS

2015

STAPLERS, NAILERS,
STAPLES & NAILS

BLOW GUNS &
TYRE INFLATORS

SPRAY GUNS, KITS
& ACCESSORIES

AIR HOSES & FITTINGS



CONTACT US:

Ph: 1300 731 818

Fax: 1300 735 858

Email: sales@spear-and-jackson.com.au

Web: www.spearandjackson.com.au





SPEAR & JACKSON

AIR TOOLS

2015

The Spear & Jackson Air Tool Range consists of a comprehensive and detailed range of blow guns, tyre inflators, staplers, nailers, spray guns, air hose, fittings and much more.

This range introduces new products and designs capable of servicing both the D.I.Y and professional user.

With over 20 years of experience, Spear & Jackson Air offers the ideal range for any hardware retailer.

Blow Guns / Tyre Inflators & Oils

Blow Guns - Plastic / Metal & Tyre Inflators	103
Air Tool / Compressor Oils	103
Mini Filter Regulator	103

Staplers, Bradders & Nailers

80 Series Stapler	104
C1 Bradder	104
Narrow Crown Stapler	104
C Bradder	104
Angle Bradder	105
Framing Nailer	105
Coil Nailer	105

Kits & Accessories

Inflation Kits & Air Tool Starter Kits	106
--	-----

Spray Guns

Gravity Feed Spray Guns & Kits	107
Suction Feed Spray Guns	107
General Purpose Spray Guns	107
In Line Moisture Trap	107

Air Hose & Fittings

Recoil Air Hose	108
Air Hose 10M & 20M	108
Hose Repair Kit	108
Fittings General, Ryco Style, Jamec Style & Nitto Style	108-109

Staples, Brads & Nails

80 Series Staples	110
Narrow Crown Staples	110
C1 Brads	110
C Brads	110
Angle Brads	110
Framing Nails	110



AIR TOOLS

blow guns, tyre inflators & oils

Blow Gun

Part No	Type	Air Inlet Size	Pack Qty
PA-AA5006	Plastic Blow Gun	1/4 inch	6



Ideal for - General cleaning, drying, dusting and multiple workshop tasks.

- Moulded Plastic Body
- Contoured Grip
- BSP Threaded Inlet
- Alloy Outlet Tube

Blow Gun - Metal

Part No	Type	Air Inlet Size	Pack Qty
PA-BGM	Metal Blow Gun	1/4 inch	6



Ideal for - General cleaning, drying, dusting, some inflating and multiple workshop tasks.

- Cast Alloy Body
- Contoured Grip
- BSP Threaded Inlet
- 3 Sizes Alloy Nozzle 25mm, 100mm, 150mm

Blow Gun Inflation Kit

Part No	Type	Air Inlet Size	Pack Qty
PA-BGIK	Blow Gun Inflation Kit	1/4 inch	6



Ideal for - Multiple inflation, cleaning, drying, dusting and general workshop tasks.

- Cast Metal Body
- Trigger Grip
- BSP Threaded Inlet
- 4 Sizes Inflation Needles (Lengths 20, 50, 78 & 100mm)

Tyre Inflator

Part No	Type	Air Inlet Size	Pack Qty
PA-AA6000	Tyre Inflator	1/4 inch	6



Ideal for - Automobile tyres, bicycle tyres and most other inflation applications

- Cast Alloy Body
- Overfill Release Button
- Moulded Grip
- BSP Style Inlet Plug
- Easy To Read Gauge
- Flexible Hose

Tyre Inflator - Deluxe

Part No	Type	Air Inlet Size	Pack Qty
PA-DT1	Deluxe Tyre Inflator	1/4 inch	6



Ideal for - Automobile tyres, farm equipment, bicycle tyres and most other inflation applications

- Alloy Body
- Overfill Release Button
- Moulded Grip
- BSP Style Inlet Plug
- Easy To Read Gauge
- Flexible Hose

Flexible & Durable Rubber Hose

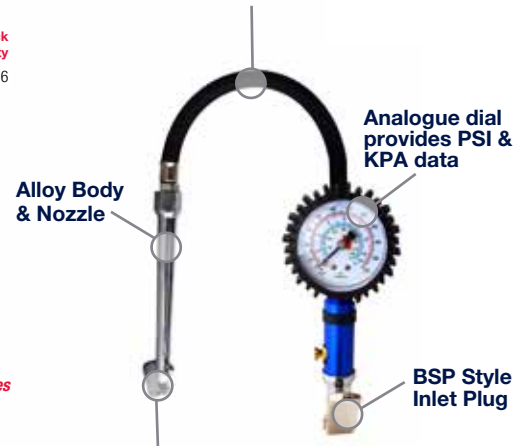

Allows for easy connection to automotive tyres and other large inflation jobs

Air Tool Oil

Part No	Type	Size	Pack Qty
CA-ATO	Air Tool Oil	1 Litre	6



Ideal for - lubricating air operated equipment.

- Suitable for Lubrication of Nailers, Staplers & Air Tools
- Can be Used with In Line Oilers

Air Compressor Oil

Part No	Type	Size	Pack Qty
CA-CAP721-04	Air Compressor Oil	1 Litre	6



Ideal for - lubricating air compressors

- Oil Is Suitable for Most Types Of Air Compressors

Mini Filter Regulator

Part No	Type	Air Inlet Size	Pack Qty
PA-14MFR	Mini Filter Regulator	1/4 inch	6



Ideal for - regulating air flow and removing moisture

- Air Flow Regulator
- Easy Read Dial Gauge
- Built In Moisture Trap
- Adjustable Mounting Bracket
- Auto Draining

AIR TOOLS staplers & bradders

80 Series Stapler

Part No	Type	Suits Nails/Staples	Pack Qty
PA-8016K	80 Series Stapler	Staples 6mm-16mm	2



Ideal for - Upholstering Furniture construction and repair, picture framing & decorative hobby work

- Cast Alloy Body
- Non Slip Rubber Grip
- Nitto Style Inlet Plug
- Alloy Magazine
- Exhaust Air Deflector
- Supplied with Brads, Goggles & Air Nailer Lubrication Oil

Custom Designed Carry Case

SIZES AVAILABLE THAT SUIT THIS STAPLER:
80 Series - 12.7mm Crown

80 Series Staple	21 Gauge / 0.81mm	6mm - 16mm
PA-8006	6mm 80 Series Staple	
PA-8008	8mm 80 Series Staple	
PA-8010	10mm 80 Series Staple	
PA-8012	12mm 80 Series Staple	
PA-8014	14mm 80 Series Staple	
PA-8016	16mm 80 Series Staple	

SIZES AVAILABLE THAT SUIT THIS NAILER:
C1 Brad - 18 Gauge / 1.25mm

C1 Style Nail/Brad	18 Gauge/1.25mm	10mm - 32mm
PA-F32/10	10mm - C1 Brad/Nail	
PA-F32/20	20mm - C1 Brad/Nail	
PA-F32/25	25mm - C1 Brad/Nail	
PA-F32/32	32mm - C1 Brad/Nail	



C1 Bradder

Part No	Type	Suits Nails/Staples	Pack Qty
PA-F32	C1 Bradder	C1 Brads 10mm-32mm	2



Ideal for - Cabinet work, trimming applications craft work & picture frames

- Cast Alloy Body
- Rubber Grip
- Nitto Style Inlet Plug
- Alloy Magazine
- Exhaust Air Deflector
- Supplied with Brads, Goggles & Air Nailer Lubrication Oil

Custom Designed Carry Case

2 In 1 Bradder / Stapler

C1 Bradder & Stapler

Part No	Type	Suits Nails/Staples	Pack Qty
PA-RP9606	2 In 1 Bradder / Stapler	C1 Brads 10mm - 32mm N/Crown Staples 16mm - 28mm	2



Ideal for - Fine cabinet work, trimming applications craft work & picture frames

- Cast Alloy Body
- Non Slip Rubber Grip
- Nitto Style Inlet Plug
- Alloy Magazine
- Exhaust Air Deflector
- Supplied with Staples, Brads, Goggles & Air Nailer Lubrication Oil

Custom Designed Carry Case

SIZES AVAILABLE THAT SUIT THIS NAILER/STAPLER:
C1 Brads - 18 Gauge / 1.25mm

C1 Style Nail/Brad	18 Gauge/1.25mm	10mm - 32mm
PA-F32/10	10mm - C1 Brad/Nail	
PA-F32/20	20mm - C1 Brad/Nail	
PA-F32/25	25mm - C1 Brad/Nail	
PA-F32/32	32mm - C1 Brad/Nail	

SIZES AVAILABLE THAT SUIT THIS NAILER/STAPLER:
Narrow Crown 18 Gauge / 1.25mm

Narrow Crown Staples	18 Gauge / 5.7mm Crown	16mm-28mm
PA-9606/16	16mm	
PA-9606/22	22mm	
PA-9606/28	28mm	

Adjustable Air Deflector

Cast Alloy Body

Trigger

Magazine Release



Suits Narrow Crown Staples 16-28mm
Suits C1 Brads 10-32mm

SUITABLE FOR

- Drawer Repairs and Trimming
- Picture Frame Assembly
- Upholstery Pinning
- Fine Cabinet Work
- Ornamental Trims
- Furniture Repair
- Hobby Work
- Mouldings
- Beading

C Bradder

Part No	Type	Suits Nails/Staples	Pack Qty
PA-C50	C Bradder	C Brads 25mm-50mm	2



Ideal for - Furniture, Cabinet work, Fixing, Finishing & Window Framing

- Cast Alloy Body
- Non Slip Rubber Grip
- Nitto Style Inlet Plug
- Alloy Magazine
- Exhaust Air Deflector
- Supplied with Brads, Goggles & Air Nailer Lubrication Oil

Custom Designed Carry Case

SIZES AVAILABLE THAT SUIT THIS NAILER:
C Brad 16 Gauge / 1.63mm

C Brad	16 Gauge / 1.63mm	25mm - 50mm
PA-C50/25	25mm - C Brad/Nail	
PA-C50/30	30mm - C Brad/Nail	
PA-C50/35	35mm - C Brad/Nail	
PA-C50/50	50mm - C Brad/Nail	



Adjustable Air Deflector

Cast Alloy Body

Trigger

Magazine - holds up to 80 C Brads

SUITABLE FOR

- Door & Window Casings
- Skirting Boards
- Architraves
- Mouldings
- Cabinets
- Facias

AIR TOOLS nailers

Angle Bradder DA 34 Degree

Part No	Type	Suits Nails/Staples	Pack Qty
PA-AB34	Angle Bradder DA 34°	34° Angle Brads 32mm - 64mm	2



Ideal for - Fixing of skirting boards and architraves, Window frames and door jambs. Angle allows access to tight corners.

- Cast Alloy Body
- Non Slip Rubber Grip
- Nitto Style Inlet Plug
- Alloy Magazine
- Exhaust Air Deflector
- Supplied with Brads, Goggles & Air Nailer Lubrication Oil

Custom Designed Carry Case

SIZES AVAILABLE THAT SUIT THIS NAILER

Angle Brad Style - DA 34 Degree 15 Gauge

Angle Brad Gal
15 Gauge / 1.83mm
32mm - 64mm

Galvanised
PA-DA32G 32mm 34° Angle Brad/Nail
PA-DA50G 50mm 34° Angle Brad/Nail
PA-DA64G 64mm 34° Angle Brad/Nail

SUITABLE FOR

- Interior & Exterior Trims
- Door & Window Casings
- Skirting Boards
- Cabinet Work
- Architraves
- Mouldings



Framing Nailer

Part No	Type	Suits Nails/Staples	Pack Qty
PA-9034	Framing Gun 34°	34° Framing Nails 50mm - 90mm	2



Ideal for - Framing applications requiring large nails or heavy duty fixing

- Cast Alloy Body
- Non Slip Rubber Grip
- Nitto Style Inlet Plug
- Alloy Magazine
- Exhaust Air Deflector
- Supplied with Goggles & Air Nailer Lubrication Oil

Custom Designed Carry Case

SIZES THAT SUIT THIS NAILER

Senco Style Clipped Head
34° Nails 50-90mm
Shank Diameter
Between 2.87mm & 3.33mm

SIZES AVAILABLE THAT SUIT THIS NAILER

Framing Nails
34 Degree
75mm

Galvanised
PA-FN75G 75mm 34° Framing Nail

SUITABLE FOR

- Applications That Use Larger Cross Section Timber
- Sub Floors - House or Decking
- Roofing Frames
- House Framing
- Fence Framing
- Truss Building



Coil Nailer

Part No	Type	Suits Nails/Staples	Pack Qty
PA-CN3	Coil Nailer 15°	Coil Nails 15° - 32mm-65mm	2



Ideal for - Building, Fencing & Decking. Uses wire and plastic collated nails.

- Cast Alloy Body
- Non Slip Rubber Grip
- Nitto Style Inlet Plug
- Alloy Magazine
- Exhaust Air Deflector
- Supplied with Goggles & Air Nailer Lubrication Oil

Custom Designed Carry Case

SIZES THAT SUIT THIS NAILER

Coil Nails
15 Degree
32mm - 65mm
Plastic or Wire Collated

Able to Use Plain, Ring or Screw Shank Nails.
Shank Size 2.3mm - 2.9mm

Additional Features

- Nail Drive Depth Adjustment
- Magazine Capacity up to 300 Nails
- 15° Magazine For Improved Access
- Side Load Canister For Ease Of Loading
- Hinged Feed Cover For Easy Jam Clearance



SUITABLE FOR

- Fencing
- Decking
- Flooring
- Plyboard
- Underlay
- Fixing & Cladding

AIR TOOLS kits & accessories

Inflation Needle Kit

Part No	Type	Air Inlet Size	Pack Qty
PA-INP	Inflation Needle Kit	1/4 inch	6



Ideal for - General cleaning, drying, dusting and multiple workshop tasks.

- 4 x Inflation Needles For Sports Balls And Other Products
- Brass Nozzle For Larger Items
- Adaptors To Increase / Decrease Thread Sizes

Inflation Kit - 6 Piece

Part No	Type	Air Inlet Size	Pack Qty
PA-6PK	6 Piece Inflation Kit	1/4 inch	6



Ideal for - General cleaning, drying, dusting and multiple workshop tasks.

- Includes:
- Fitted Recoil Hose
 - Tyre Inflator
 - Metal Bodied Blow Gun
 - Inflation Nozzles x 3

Inflation Kit - 14 Piece

Part No	Type	Air Inlet Size	Pack Qty
PA-14PIK	14 Piece Inflation Kit	1/4 inch	8



Ideal for - An entire range of inflating including sports balls, toys, mattresses & more. This kit also contains all the necessary fittings and accessories to get you started.

- Includes:
- Tyre Chuck x 1
 - Tyre Gauge x 1
 - Female Quick Coupler x 1
 - Nitto Style 1/4" Male Quick Plugs x 4
 - 1/4" Nitto Style Female Quick Plugs x 2
 - Hose Connectors x 2
 - Safety Nozzle x 1
 - Inflation Needle x 1
 - Metal Bodied Blow Gun x 1

Blow Gun & Inflation Kit - 20 Piece

Part No	Type	Air Inlet Size	Pack Qty
PA-20BGTIK	20 Piece Blow Gun & Inflation Kit	1/4 inch	6



Ideal for - An entire range of inflating including automotive tyres, sports balls, toys & more. This kit also contains all the necessary fittings and accessories to get you started.

- Includes:
- Tyre Inflator / Blow Gun with Moulded Grip x 1
 - Gauge and Overfill Release
 - Nitto Style 1/4" Female Plugs x 3
 - Nitto Style 1/4" Male Plugs x 2
 - Nitto Style 1/4" Male Coupler x 1
 - Tyre Chuck
 - Inflation Nozzles
 - Tyre Inflator Attachment
 - Adaptors x 4

Air Tool Starter Kit - 30 Piece

Part No	Type	Air Inlet Size	Pack Qty
PA-30PIK	30 Piece Air Tool Starter Kit	1/4 Inch	6



Ideal for - A range of air related jobs including cleaning, spraying, inflating & dusting. This kit is perfect for first time users and contains everything you need to get you started.

- Includes:
- Spray Gun
 - Blow Gun
 - Tyre Inflator with Gauge
 - 10m Recoil Hose
 - Cleaning Kit
 - Blow Gun Nozzles x 2
 - Nitto Style 1/4" Female Couplers x 2
 - Nitto Style 1/4" Female Plugs x 2
 - Nitto Style 1/4" Male Plugs x 2
 - Adaptors x 4
 - Inflation Needles x 2
 - Dusk Masks x 11



Recoil Hose
10m Coiled Length
1/4" BSP Fitted Ends
Flexible & Easy To Use



Spray Gun
Adjust.. Spray Pattern
1.5mm Fluid Nozzle
750cc Alloy Pot



Tyre Inflator
Cast Alloy Body
Overfill Release Button
Moulded Grip



Nitto Style Fittings
All Steel Construction
Nitto Style Fittings
1/4" BSP Thread



Inflation Needles
Ideal for inflating toys,
sports equipment &
accessories



Blow Gun
Cast Metal Body
Trigger Grip
BSP Threaded Inlet

AIR TOOLS spray guns

Gravity Feed

Part No	Type	Pot Size	Pack Qty
PA-BSG	Gravity Feed Spray Gun	600cc	6



Ideal for - Affordable spraying, ideal for undercoats and preparation tasks.

- 1.5mm Fluid Nozzle
- 600cc Pot
- Pattern Width 160-230mm
- Spray Pattern Adjustment
- Material and Air Flow Adjustment
- Air Inlet with 1/4" BSP Thread

Suction Feed

Part No	Type	Pot Size	Pack Qty
PA-SFG	Suction Feed Spray Gun	750cc	6



Ideal for - Affordable spraying, ideal for undercoats and preparation tasks.

- 1.5mm Fluid Nozzle
- 750cc Alloy Pot
- Pattern Width 140mm x 180mm
- Spray Pattern Adjustment
- Material and Air Flow Adjustment
- Air Inlet with 1/4" BSP Thread

In Line Moisture Trap

Part No	Type	Air Inlet Size	Pack Qty
PA-14ILMT	In line Moisture Trap	1/4 Inch	6



Ideal for - Reducing the moisture level in the outlet air. Moisture reduces air tool life and degrades paint finish.

- Glass Body For Viewing Trapped Moisture
- Used To Reduce Moisture in Air Lines
- Operates Best When Mounted Vertically
- Used With Air Tools and Spray Guns

General Purpose

Part No	Type	Pot Size	Pack Qty
PA-LPSG	General Purpose Spray Gun	600cc	6



Ideal for - Small to Medium spraying tasks.

- 1.5mm Fluid Nozzle
- 600cc Alloy Pot
- Pattern Width 180-250mm
- Spray Pattern Adjustment
- Material and Air Flow Adjustment
- Air Inlet with 1/4" BSP thread



NOTE: Spear & Jackson Spray Guns Will Not Spray Water or Oil Based House Paint!



Spraying Tips

- For a great finish, the thinned paint should be the consistency of milk.
- Always use a test piece before spraying your project.
- Preparation is the key to a good finish. Make sure surface is clean and smooth before spraying.
- Make smooth even passes about 200mm from the job.
- Do not overload the job with paint. Multiple light coats will stop paint runs and sags.

Deluxe

Part No	Type	Pot Size	Pack Qty
PA-S770	Deluxe Spray Gun	1000cc	6



Ideal for - Medium to large spraying tasks.

- 2mm Fluid Nozzle
- 1000cc Alloy Pot
- Pattern Width 180-250mm
- Spray Pattern Adjustment
- Material and Air Flow Adjustment
- Air Inlet with 1/4" BSP thread

Gravity Feed Kit

Part No	Type	Pot Sizes	Pack Qty
PA-GFSK	Gravity Feed Kit	Spray Gun - 125cc Touch Up Gun - 600cc	6



Ideal for - Covers small touch up or patch repairs to medium sized spraying tasks.

- 2 Gun Kit with Regulator
- Touch Up & Full Size Spray Gun
- 125 & 600cc Pots
- Spray Pattern Adjustment
- Material and Air Flow Adjustment
- Air Inlet with 1/4" BSP thread

Spray Gun
600CC Plastic Pot
Touch Up Spray Gun
125cc Plastic Pot
Spray Nozzle
Material Flow Adjustment
1/4" BSP Style Air Inlet
Cast Alloy Body
Air Regulator

Spray Gun
Operating Pressure 15-45psi
Air Consumption 6-8 CFM

Touch Up Spray Gun
Operating Pressure 15-45psi
Air Consumption 3.5-6 CFM

Safety and Usage Instructions

- Do not use house paint
- Wear protective clothing
- Store paint and thinners safely
- Thoroughly clean gun after use
- Never spray in a confined area

AIR TOOLS hose & fittings

Recoil Hose 10m

Part No	Type	Length	Pack Qty
PA-RH10M	PE Recoil Hose 10 Metre	10 Metre	12



Ideal for - Connecting your air tool to a compressor within a 10m distance. Suitable for low pressure applications

- 10m Coiled Length
- Fitted With 1/4 Inch Nitto Style Fittings
- Flexible & Easy To Use
- Compact To Store

Air Hose 10m & 20m

Part No	Type	Length	Pack Qty
PA-AH10M	Air Hose PVC 10 Metre	10 Metre	5
PA-AH20M	Air Hose PVC 20 Metre	20 Metre	5



Ideal for - Connecting your air tool to a compressor. Suitable for higher pressure applications

- Strong PVC Body
- Fitted With 1/4 Inch BSP Type Fittings
- 10 & 20m Lengths Available
- 16mm Outer Diameter

Hose Repair Kit

Part No	Type	Material	Pack Qty
PA-HSRK	Hose Repair Kit	Brass	12



Ideal for - Terminating & Repairing Air Hose

- Brass Hose Joiner
- Brass Barbed Plug
- 3x Hose Clamps

General Fittings

Connector - Male

Part No	Type	Material	Pack Qty
PA-FP-12	Connector Male 1/4" BSP Thread	Steel	6



Ideal for - Quick and safe attachment of air tools & accessories

- 1/4" Male to Male Fitting

Connector - Female

Part No	Type	Material	Pack Qty
PA-FP-52	Connector Female 1/4" BSP Thread	Steel	6



Ideal for - Quick and safe attachment of air tools & accessories

- 1/4" Female to Female Fitting

Adaptor

Part No	Type	Material	Pack Qty
PA-FP-6-3	Adaptor 1/4" to 3/8" BSP Thread	Steel	6



Ideal for - Quick and safe attachment of air tools & accessories

- 1/4" Female to 3/8" Male

Hose End - Male

Part No	Type	Material	Pack Qty
PA-FP-19	Hose End Male 1/4" BSP Thread	Steel	6



Ideal for - Quick and safe attachment of air tools & accessories

- 1/4" Male 10mm Fitting

Hose End - Female

Part No	Type	Material	Pack Qty
PA-FP-59	Hose End Female 1/4" BSP Thread	Steel	6



Ideal for - Quick and safe attachment of air tools & accessories

- 1/4" Female 10mm Fitting

Inline Stop Valve

Part No	Type	Material	Pack Qty
PA-F2020FM	Inline Stop Valve 1/4" BSP Thread	Steel	6



Ideal for - Quick and safe attachment of air tools & accessories

- Inline Stop Valve 1/4"

Ryco Style Fittings

Plug - Male

Part No	Type	Material	Pack Qty
PA-R20PM	Male Plug 1/4" BSP Thread	Steel	6



Ideal for - Quick and safe attachment of air tools & accessories

- Male Plug 1/4" BSP Thread

Plug - Female

Part No	Type	Material	Pack Qty
PA-R20PF	Female Plug 1/4" BSP Thread	Steel	6



Ideal for - Quick and safe attachment of air tools & accessories

- Female Plug 1/4" BSP Thread

Fittings Pack 6pcs

Part No	Type	Material	Pack Qty
PA-R6PCD	6 Piece Fittings Pack	Steel	6

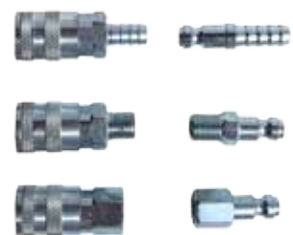

Ideal for - Quick and safe attachment of air tools & accessories

- Includes:
- Male Coupler
 - Male Plug
 - Barbed Coupler
 - Female Coupler
 - Female Plug
 - Barbed Plug

Coupler - Male

Part No	Type	Material	Pack Qty
PA-R20SM	Male Coupler 1/4" BSP Thread	Steel	6



Ideal for - Quick and safe attachment of air tools & accessories

- Male Coupler 1/4" BSP Thread

Coupler - Female

Part No	Type	Material	Pack Qty
PA-R20SF	Female Coupler 1/4" BSP Thread	Steel	6



Ideal for - Quick and safe attachment of air tools & accessories

- Female Coupler 1/4" BSP Thread

AIR TOOLS fittings

Jamec Style Fittings Plug - Male

Part No	Type	Material	Pack Qty
PA-J20PM	Male Plug 1/4" BSP Thread	Steel	6



Ideal for - Quick and safe attachment of air tools & accessories
 • Male Plug 1/4" BSP Thread

Plug - Female

Part No	Type	Material	Pack Qty
PA-J20PF	Female Plug 1/4" BSP Thread	Steel	6



Ideal for - Quick and safe attachment of air tools & accessories
 • Female Plug 1/4" BSP Thread

Fittings Pack 6pcs

Part No	Type	Material	Pack Qty
PA-J6PCD	6 Piece Fittings Pack	Steel	6



Ideal for - Quick and safe attachment of air tools & accessories
 Includes:
 • Male Coupler
 • Male Plug
 • Barbed Coupler
 • Female Coupler
 • Female Plug
 • Barbed Plug

Coupler - Male

Part No	Type	Material	Pack Qty
PA-J20SM	Male Coupler 1/4" BSP Thread	Steel	6



Ideal for - Quick and safe attachment of air tools & accessories
 • Male Coupler 1/4" BSP Thread

Coupler - Female

Part No	Type	Material	Pack Qty
PA-J20SF	Female Coupler 1/4" BSP Thread	Steel	6



Ideal for - Quick and safe attachment of air tools & accessories
 • Female Coupler 1/4" BSP Thread

Nitto Style Fittings Plug - Male

Part No	Type	Material	Pack Qty
PA-N20PM	Male Plug 1/4" BSP Thread	Steel	6



Ideal for - Quick and safe attachment of air tools & accessories
 • Male Plug 1/4" BSP Thread

Plug - Female

Part No	Type	Material	Pack Qty
PA-N20PF	Female Plug 1/4" BSP Thread	Steel	6



Ideal for - Quick and safe attachment of air tools & accessories
 • Female Plug 1/4" BSP Thread

Coupler - Male

Part No	Type	Material	Pack Qty
PA-N20SMO	Male Coupler 1/4" BSP Thread	Steel	6



Ideal for - Quick and safe attachment of air tools & accessories
 • Male Coupler 1/4" BSP Thread

Coupler - Female

Part No	Type	Material	Pack Qty
PA-N20SFO	Female Coupler 1/4" BSP Thread	Steel	6

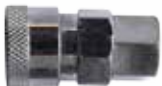

Ideal for - Quick and safe attachment of air tools & accessories
 • Female Coupler 1/4" BSP Thread

Plug - Barbed

Part No	Type	Material	Pack Qty
PA-N30PH	Barbed Plug	Steel	6



Ideal for - Quick and safe attachment of air tools & accessories
 • Barbed Coupler
 • To Suit 10mm Hose

Coupler - Barbed

Part No	Type	Material	Pack Qty
PA-N30SHO	Barbed Coupler	Steel	6



Ideal for - Quick and safe attachment of air tools & accessories
 • Barbed Coupler
 • To Suit 10mm Hose

Fittings Pack 5pcs

Part No	Type	Material	Pack Qty
PA-N5PC	5 Piece Fittings Pack	Steel	12



Ideal for - Quick and safe attachment of air tools & accessories

Includes:
 • Male Coupler
 • Male Plug
 • Female Coupler
 • Female Plug x2

Fittings Pack 6pcs

Part No	Type	Material	Pack Qty
PA-N6PCD	6 Piece Fittings Pack	Steel	6



Ideal for - Quick and safe attachment of air tools & accessories

Includes:
 • Male Coupler
 • Male Plug
 • Barbed Coupler
 • Female Coupler
 • Female Plug
 • Barbed Plug

2 Way Splitter

Part No	Type	Material	Pack Qty
PA-NSPLIT	2 Way Splitter	Steel	6



Ideal for - Quick and safe attachment of air tools & accessories

• 1/4" Female BSP
 • 2 x Couplers
 • Can be connected direct to compressor or air hose

AIR TOOLS staples & nails

80 Series Staples

Part No	Type	Size	Pieces Per Box	Pack Qty
PA-8006	80 Series Staple	6mm	1000	6
PA-8008	80 Series Staple	8mm	1000	6
PA-8010	80 Series Staple	10mm	1000	6
PA-8012	80 Series Staple	12mm	1000	6
PA-8014	80 Series Staple	14mm	1000	6
PA-8016	80 Series Staple	16mm	1000	6



Ideal for - Upholstering Furniture construction and repair, picture framing & decorative hobby work

- Suitable For Use With PA-8016K Stapler
- Crown Width 12.8mm
- 6mm/8mm/10mm/12mm/14mm/16mm
- 1000 Pieces per Box

80 Series Staple



21 Gauge / 0.95 x 0.65mm

80 Series Staple
21 Gauge / 0.81mm
6mm - 16mm



PA-8006	6mm 80 Series Staple
PA-8008	8mm 80 Series Staple
PA-8010	10mm 80 Series Staple
PA-8012	12mm 80 Series Staple
PA-8014	14mm 80 Series Staple
PA-8016	16mm 80 Series Staple

Narrow Crown Staple



18 Gauge

Narrow Crown Staples
18 Gauge / 5.7mm Crown
16mm-28mm

PA-9606/16	16mm
PA-9606/22	22mm
PA-9606/28	28mm

Narrow Crown Staples

Part No	Type	Size	Pieces Per Box	Pack Qty
PA-9606/16	Narrow Crown Staples	16mm	1000	6
PA-9606/22	Narrow Crown Staples	22mm	1000	6
PA-9606/28	Narrow Crown Staples	28mm	1000	6



Ideal for - Fine cabinet work, trimming applications craft work & picture frames

- Suitable For Use With PA-RP9606 2 in 1 Bradder / Stapler
- Crown Width 5.7mm
- 16mm/22mm/28mm
- 1000 Pieces per Box

C1 Brads

Part No	Type	Size	Pieces Per Box	Pack Qty
PA-F32/10	C1 Brads	10mm	2500	6
PA-F32/20	C1 Brads	20mm	2500	6
PA-F32/25	C1 Brads	25mm	2500	6
PA-F32/32	C1 Brads	30mm	2500	6



C1 Brads



C1 Style Nail/Brad
18 Gauge / 1.25mm
10mm - 32mm



PA-F32/10	10mm - C1 Brad/Nail
PA-F32/20	20mm - C1 Brad/Nail
PA-F32/25	25mm - C1 Brad/Nail
PA-F32/32	32mm - C1 Brad/Nail

Ideal for - Cabinet work, trimming applications craft work & picture frames

- To be Used with PA-F32 C1 Bradder
- 18 Gauge/1.25mm
- 10mm/20mm/25mm/32mm
- 2500 Pieces per Box

C Brads

Part No	Type	Size	Pieces Per Box	Pack Qty
PA-C50/25	C Brads	25mm	2500	6
PA-C50/30	C Brads	30mm	2500	6
PA-C50/35	C Brads	35mm	2500	6
PA-C50/50	C Brads	50mm	2500	6



C Brads



C Brad
16 Gauge / 1.63mm
25mm - 50mm

PA-C50/25	25mm - C Brad/Nail
PA-C50/30	30mm - C Brad/Nail
PA-C50/35	35mm - C Brad/Nail
PA-C50/50	50mm - C Brad/Nail

Ideal for - Furniture, Cabinet work, Fixing, Finishing & Window Framing

- To be Used with PA-C50 C Bradder
- 18 Gauge/1.25mm
- 25mm/30mm/35mm/50mm
- 2500 Pieces per Box

Angle Brads

Part No	Type	Size	Pieces Per Box	Pack Qty
PA-DA32G	Angle Brads 34° Galvanised	32mm	1000	6
PA-DA50G	Angle Brads 34° Galvanised	50mm	1000	6
PA-DA64G	Angle Brads 34° Galvanised	64mm	1000	6

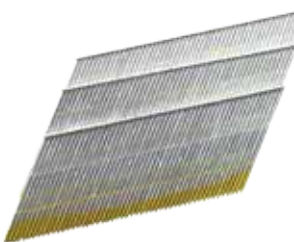

Angle Brads



Angle Brad Gal
15 Gauge / 1.83mm
32mm - 64mm



Galvanised	PA-DA32G 32mm 34° Angle Brad/Nail
Galvanised	PA-DA50G 50mm 34° Angle Brad/Nail
Galvanised	PA-DA64G 64mm 34° Angle Brad/Nail

Ideal for - Fixing of skirting boards and architraves, Window frames and door jambs. Angle allows access to tight corners.

- To be Used with PA-AB34 Angle Bradder
- 15 Gauge/1.8mm
- 32mm/50mm/64mm
- 34 Degree Galvanised
- 1000 Pieces per Box
- Suited to Mild Outdoor Exposure

Framing Nails



Shank Diameter
between 2.87mm & 3.33mm

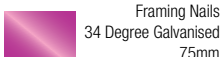

Galvanised	PA-FN75G 75mm 34° Framing Nail
------------	--------------------------------

Framing Nails

Part No	Type	Size	Pieces Per Box	Pack Qty
PA-FN75G	Framing Nails 34° Galvanised	75mm	500	6

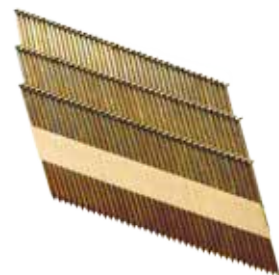

Ideal for - Framing applications requiring large nails or heavy duty fixing

- To be Used with PA-9034 Framing Gun
- 34 Degree Galvanised
- 75mm
- 500 Pieces per Box
- Suited to Mild Outdoor Exposure



CELEBRATING
OVER
250
YEARS
OF EXPERIENCE

CONTACT US:

Ph: 1300 731 818

Fax: 1300 735 858

Email: sales@spear-and-jackson.com.au

Web: www.spearandjackson.com.au



VISIT US ONLINE

Due to continuous product development and improvement, Spear & Jackson reserves the right to modify product design, specifications and materials without prior notice.



SPEAR & JACKSON

ECLIPSE

PROFESSIONAL TOOLS

Product Guide
2015
AUSTRALIA



CONTENTS

Metal Cutting

Hacksaw & Small Saw Blades	115 - 117
Saw Frames	118 - 119
Saw Tooth Setter	119
Aviation Snips	119
Bolt Cutters	120

Chisels

Flat, Crosscut, Floorboard & Concrete Point Chisels	121
---	-----

Locking Jaw Pliers

Locking Jaw Pliers	122 - 125
C-Clamps	125

Workholding Solutions

Vices	126 - 129
G-Clamps	129
One Handed Bar Clamps	130
F Clamps	130
Sash Clamps	131
T Bar Clamps	131
Magnetic Workholding	132
Magnetic Chucks	132-133

Magnetic Lifters

Ultralift Plus+	134 - 135
Ultralift TP	136

Wrenches

Aluminium Pipe Wrenches	137 - 138
Adjustable Wrenches	139

Riveters & Threaded Insert Setting Tools

Riveters	140 - 141
Threaded Instert Setting Tools & Kits	142

Engineers' Tools

Scrapers, Pin Vices, Chucks & Collets	143 - 144
Nut Spinners & Punches	146
Tap Wrenches & Trammel Heads	145
Combination Squares & Sets	145

Magnetic Solutions

Permanent Magnets - Magnet Materials	146 - 147
Pot Magnets & Hook Magnets	148



CELEBRATING
OVER
100
YEARS
OF EXPERIENCE

**HACKSAW BLADES
SPECIALTY SAW BLADES
SAW FRAMES
SNIPS
BOLT CUTTERS
CHISELS**

**SUPER
HARDENED**

Eclipse saw blade robot



**ECLIPSE - THE NUMBER ONE NAME
IN METAL CUTTING**

With a proud history of hacksaw blade manufacture stretching back nearly 100 years, Eclipse hacksaw blades have become synonymous with engineering excellence and continuous product development. As a result, Eclipse is now firmly established as the number one global metal cutting brand.

**ECLIPSE PLUS 30 - A
REVOLUTIONARY BLADE DESIGN**

Following many years of research into the most effective cutting profile possible, Neill Tools has developed an entirely new blade tooth shape that enables a 30 percent faster cut over conventional blades. The result of this is the Eclipse Plus 30 range.

Why are Eclipse Plus 30 blades faster?
- They are precision-ground to the finest tolerances, making them much sharper than conventional milled blades.



Their tooth geometry has been designed to give a positive rake angle that is more aggressive and therefore faster than conventional milled blades. Our tests show a 30% faster cut, hence the name 'Plus 30'.

**ECLIPSE PLUS 30 - CONFIRMED BY
INDEPENDENT TESTING**

Independent testing by the University of Northumbria in Newcastle has verified the claims made about the Eclipse Plus 30 blade. Using both machine and hand testing, the Eclipse Plus 30 has been thoroughly tested and the improvement in cutting ability has been confirmed.

These two inset shots illustrate the difference between a ground and a milled blade under magnification.

MILLED TOOTH SHAPE - STANDARD



GROUND TOOTH SHAPE - PLUS 30



HAND HACKSAW BLADES

Plus 30 Flexible BiMetal HSS

Part No	Blade Size mm	Blade Size inches	Teeth per 25mm	PIN dia. mm	Pack Size
EC-AA3045E	300 x 12.5 x 0.63	12 x 1/2 x 0.02	18	4	100
EC-AA3046V	300 x 12.5 x 0.63	12 x 1/2 x 0.02	24	4	100
EC-AA3047R	300 x 12.5 x 0.63	12 x 1/2 x 0.02	32	4	100



A virtually unbreakable bimetal blade for superb cutting performance, wear resistance and safety.

The combination of an M2 High Speed ground cutting edge, electron-beam welded to a flexible alloy back gives a level of cutting power and flexibility that is far superior to edge hardened or conventional flexible blades.

The unique ground tooth profile of the Plus 30 blade produces a faster and more aggressive cutting action that requires less effort and is more efficient than a standard blade.

Cuts through all types of metals including alloy and stainless steels.

A rigid, All Hard ground blade for highly accurate cutting and long life.

- 30% MORE CUTTING POWER
- SHARPER FIRST CUT
- LONGER LIFE

Flexible Shatterproof HSS

Part No	Blade Size mm	Blade Size inches	Teeth per 25mm	PIN dia. mm	Pack Size
EC-AS45A	300x12.5x0.63	12x 1/2 x 0.025	18	4	100
EC-AS46D	300x12.5x0.63	12x 1/2 x 0.025	24	4	100
EC-AS47P	300x12.5x0.63	12x 1/2 x 0.025	32	4	100



A virtually unbreakable, edge hardened blade, which offers flexibility and safety but less wear resistance than an All Hard or bimetal blade.

- EDGE HARDENED
- SHATTERPROOF BLADE
- LONGER LIFE

Flexible BiMetal HSS

Part No	Blade Size mm	Blade Size inches	Teeth per 25mm	PIN dia. mm	Pack Size
EC-AA45E	300 x 12.5 x 0.63	12 x 1/2 x 0.025	18	4	100
EC-AA46V	300 x 12.5 x 0.63	12 x 1/2 x 0.025	24	4	100
EC-AA47R	300 x 12.5 x 0.63	12 x 1/2 x 0.025	32	4	100



A virtually unbreakable bimetal blade for superb cutting performance, wear resistance and safety.

The combination of an M2 High Speed cutting edge and electron-beam welded to a flexible alloy back gives a level of cutting power and flexibility that is far superior to edge hardened or conventional flexible blades.

Cuts through all types of metals including alloy and stainless steels.

- HIGH PERFORMANCE
- SHATTERPROOF BLADE

All Hard HSS

Part No	Blade Size mm	Blade Size inches	Teeth per 25mm	PIN dia. mm	Pack Size
EC-AE45B	300x12.5x0.63	12 x 1/2 x 0.025	18	4	100
EC-AE46X	300x12.5x0.63	12 x 1/2 x 0.025	24	4	100
EC-AE47K	300x12.5x0.63	12 x 1/2 x 0.025	32	4	100



A rigid, All Hard blade for highly accurate cutting and long life.

Manufactured entirely from top quality High Speed Steel, each blade is precisely hardened throughout its entire width to give a strong, rigid back, ensuring a perfectly straight cut time after time.

For the best performance from All Hard blades the workpiece should be securely held in a clamp or vice to prevent shattering of the blade and safety goggles should be worn.

Cuts through all types of metals including alloy and stainless steels.

- ACCURATE CUTTING
- LONG LIFE

Flexible Silicon Shatterproof

Part No	Blade Size mm	Blade Size inches	Teeth per 25mm	PIN dia. mm	Pack Size
EC-AM45W	300x12.5x0.63	12 x 1/2 x 0.025	18	4	100
EC-AM46B	300x12.5x0.63	12 x 1/2 x 0.025	24	4	100
EC-AM47X	300x12.5x0.63	12 x 1/2 x 0.025	32	4	100



A virtually unbreakable blade suitable for DIY use.

Manufactured from low alloy silicon steel, this blade is ideal for general purpose sawing of mild steel, brass, aluminium, copper and other soft metals.

- GENERAL PURPOSE
- SHATTERPROOF BLADE



HAND HACKSAW BLADES

HAND BLADE TOOTH PITCH SELECTION

To select the hacksaw blade with the correct number of teeth for the task, consider the following elements:

- How thick is the material to be cut?
For thin sections, the highest number of teeth should be used and vice versa for thicker sections.

What type of material is to be cut?

- The table opposite is a guide to tooth pitch selection for different materials and various thicknesses.



WORKPIECE MATERIAL	WORKPIECE THICKNESS				
	mm inch	3 1/8	6 1/4	10 3/8	13 1/2
Magnesium	32				
Aluminium		24			
Free Machining		18			
Brass, Copper, Carbon Steels, Low and Medium Carbon Structural Steels	32		24		18
High Carbon Steels, Bronze, Tool Steels, Die Steel, Alloy Steels, Stainless Steels, Copper Alloys Malleable Cast Iron, Titanium Alloys, High Temperature Alloys (Inconel, Nimonic, Hastelloy, Incolony), Nickel Alloys (Monel, Duranickel)	32			24	18

SMALL SAW BLADES

Part No	Description	Length	Teeth per 25mm	No. of blades in pack	Pack Size	Box Weight (kg)
EC-71-624R	Triple pack of Hacksaw Blades		-	10	0.9	
	- Bimetal Blades	300mm (12")	18	1	-	-
	- Bimetal Blades	300mm (12")	24	1	-	-
	- Bimetal Blades	300mm (12")	32	1	-	-
SJ-71/132R	Junior Blades	150mm (6")	32	10	10	-
SJ-71/114R	Junior-Wood	150mm (6")	14	10	10	-
SJ-71/CP7R	Coping Saw Blades	165mm (6 1/2")	14	10	10	-
SJ-71/FS5R	Fretsaw Blades	125mm (5")	18	10	10	-
SJ-73/66SR	GP Saw Spare Blade	375mm (15 3/4")	10	1	10	-
EC-FS16	Fretsaw Blades	125mm (5")	16	100	1	0.30
EC-FS18	Fretsaw Blades	125mm (5")	18	100	1	0.30
EC-FS22	Fretsaw Blades	125mm (5")	22	100	1	0.30
EC-FS32	Fretsaw Blades	125mm (5")	32	100	1	0.30
EC-PS44	Piercing Saw Blades	125mm (5")	44	100	1	0.20
EC-PS32	Piercing Saw Blades	125mm (5")	32	100	1	0.20



SAW FRAMES

Can maintain blade tension at over 80kgs to ensure accurate and straight cutting performance

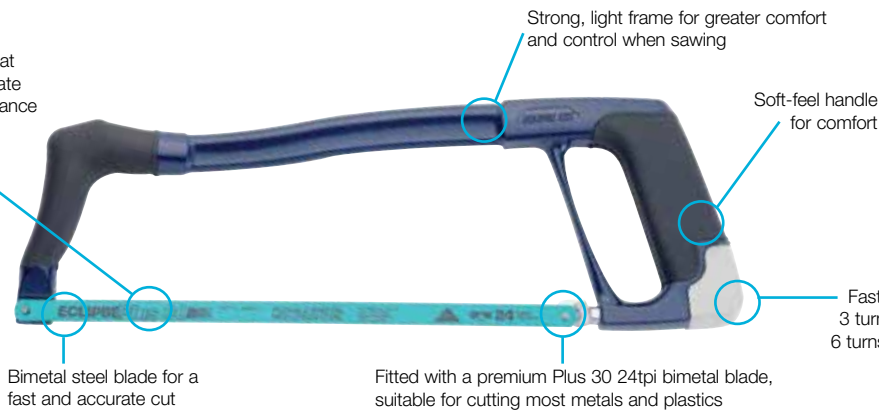

Professional Hacksaw - Soft Grip

Part No	Description	Length	Height	Pack
EC-70-22TR	Hacksaw SF	400mm(16")	132mm(5 1/4")	5



The new 22T has soft-feel handle, Epoxy coated moulded section steel frame and comes complete with an Eclipse +30 bimetal blade

Professional Hacksaw

Part No	Description	Length	Height	Pack
EC-20TND	Prof. Hacksaw	465mm(18 3/8")	130mm(5")	6



The world famous, best selling hacksaw featuring a die cast handle, tubular frame complete with an **ECLIPSE** bimetal blade. The 20T has set the standard for all other makes - but the best is still the original 20T from **ECLIPSE**

Hacksaw

Part No	Description	Length	Height	Pack
EC-422	Hacksaw - Box Frame	400mm(18")	135mm(5 1/4")	6



A lightweight, economical hacksaw with a strong, box section tubular steel frame and a comfortable soft grip handle. Adjustable blade tensioning for 55 degree cutting, can also be used as a Compass Saw.

Hacksaw - Fluro Orange

Part No	Description	Length	Height	Pack
EC-424	Hacksaw - Box Frame	400mm(18")	135mm(5 1/4")	6



A lightweight, economical hacksaw with a strong, box section tubular steel frame and a comfortable soft grip handle. Fluorescent orange body highlights for easy visibility. Adjustable blade tensioning for 55 degree cutting, can also be used as a Compass Saw.

Hacksaw - Lightweight

Part No	Description	Length	Height	Pack
EC-16TND	Hacksaw	430mm (16 5/16")	132mm(5 1/4")	10



A lightweight, economical hacksaw with a strong, box section tubular steel frame and a comfortable and durable cast aluminium handle. In addition, the extra long location pin gives increased security of the tensioning bit. Comes complete with an **ECLIPSE** bimetal blade

Mini Hacksaw

Part No	Description	Length	Height	Pack
EC-70-675R	Mini Saw	250mm(10")	100mm(4")	30



A more substantial version of the Junior hacksaw with plastic moulded pistol grip handle, steel frame and **ECLIPSE** blade. Blade tensioning device incorporated in the handle

Coping Saw - Soft feel handle

Part No	Description	Length	Height	Pack
EC-70-CP1RSF	Coping Saw SF	317mm(12 3/8")	130mm(5 1/8")	5



Coping saw for cutting and shaping wood, with a soft-feel handle for extra comfort and steel frame. Blades can be positioned at any angle to the frame

Fret Saw - Soft feel handle

Part No	Description	Length	Height	Pack
EC-70-FS1RSF	Fret	270mm(10 5/8")	300mm(11 7/8")	5



Fretsaw for fine cutting work in thin materials such as wood, bone, plastics, etc - ideal for model makers. Comfortable soft feel handle and steel frame

Piercing Saw - Soft feel handle

Part No	Description	Length	Height	Pack
EC-PS51SF	Piercing Saw	290mm(18 1/4")	90mm (3 1/2")	5



Piercing saw is ideal for fine metalwork and jewellery. Comfortable soft feel handle and steel frame. Spring steel blade with precision milled teeth, cuts on backward stroke.

STATEMENT OF CONFORMITY

Hacksaw Frames - in general compliance with British Standard BS 7398 : 1991 - Specification for hand hacksaw frames.

SAW TOOTH SETTER, JEWELLERS & AVIATION SNIPS

General Purpose Saw



General purpose saw for cutting through wood, plastics and soft metals (such as nails). Polyester coated blade and diecast 9 position handle to enable cutting in difficult positions

Part No	Description	Length	Height	Pack
SJ-72/66XR	General Purpose	465mm(18 1/4")	-	5

Junior Hacksaw



The Junior Hacksaw is universally designed to cut through metals, wood and some plastics. It features a 6" (150mm) replaceable blade and is the perfect choice for smaller jobs.

Part No	Description	Length	Height	Pack
SJ-71-14JR	Junior Hacksaw	260mm	70mm	12

Saw Tooth Setter



Used for setting teeth during the sharpening of handsaws. Solid steel construction with soft poly grips for extra comfort when in use.

Part No	Description	Length	Height	Pack
EC-94/370R	Saw Tooth Setter	180mm (7 1/4")	90mm (3 1/2")	2

Coping Saw - Timber Handle



Coping saw for cutting and shaping wood, with a strong timber handle and steel frame. Blades can be positioned at any angle to the frame

Part No	Description	Length	Height	Pack
SJ-7CP	Coping Saw - Timber Handle	310mm	140mm	10

Aviation Snips



Cuts up to 1.2mm cold rolled steel and 0.7mm stainless steel. Drop forged alloy steel blades give a longer cutting life, whilst the spring loaded handles ensure a fast, smooth cutting action

Part No	Description	Cutting Capacity (cold rolled steel)	Cutting Capacity (stainless steel)	Pack
EC-EAS-S	Straight and Wide Curves	1.22mm	0.7mm	6
EC-EAS-R	Right and Straight Cut	1.22mm	0.7mm	6
EC-EAS-L	Left and Straight Cut	1.22mm	0.7mm	6
EC-EAS-SL	Long Cut / Straight Cut & Wide Curves	1.22mm	0.7mm	6

Jewellers' Snips



For cutting copper, silver, gold and other soft metals. The precision hollow ground blades reduce friction for an easy cutting action and, since they are also induction hardened and tempered, they can be easily re-sharpened. Integrated stops prevent trapped fingers without compromising the jaw capacity

Part No	Size	Cutting Capacity (mild steel up to 18g)	Cutting Capacity (stainless steel up to 23g)	Pack
EC-ESJ7S	7" / 180mm (straight blade)	0.8mm	0.46mm	10
EC-ESJ7C	7" / 180mm (curved blade)	0.8mm	0.46mm	10

General Purpose Snips



For cutting sheet metal. The precision hollow ground blades reduce friction for an easy cutting action and since they are also induction hardened and tempered, they can be easily re-sharpened. The spring loaded nut allows for easy adjustment to increase the working life, whilst the high quality steel drop forged handles offer maximum strength

Part No	Total Length	Cutting Capacity (mild steel up to 18g)	Cutting Capacity (stainless steel up to 23g)	Pack
EC-ESGP8	8" (200mm)	0.8mm	0.46mm	6
EC-ESGP10	10" (250mm)	1.0mm	0.46mm	6
EC-ESGP12	12" (300mm)	1.2mm	0.46mm	6
EC-ESGP14	14" (355mm)	1.4mm*	1.2mm**	6

BOLT CUTTERS

Bolt Cutters - High Tensile, Tubular Handles

Part No	Total Length	Max. Cutting Capacity	Pack
EC-ETBC14	14" (355mm)	3/16" / 5.0mm	20
EC-ETBC18	18" (460mm)	1/4" / 6.4mm	10
EC-ETBC24	24" (610mm)	5/16" / 7.9mm	8
EC-ETBC30	30" (762mm)	3/8" / 9.5mm	5
EC-ETBC36	36" (915mm)	7/16" / 11.1mm	4

Centre Cut



High tensile - for cutting hard materials up to 50HRC. Centre cut, strap adjusted bolt cutters with lightweight tubular handles that do not compromise strength – every pound of force applied is amplified to produce 80lbs (36kg) of force between the jaws. To maximise safety the built in stops will yield rather than break, whilst the drop forged jaws are machined to precise specifications for a resilient body and rigid cutting edge

Part No

EC-ETBC14RH2

EC-ETBC18RH2

EC-ETBC24RH2

EC-ETBC30RH2

EC-ETBC36RH2

Spares For Boltcutters - Tubular Handles

Replacement Jaws & Strap Set 14" (355mm)

Replacement Jaws & Strap Set 18" (460mm)

Replacement Jaws & Strap Set 24" (610mm)

Replacement Jaws & Strap Set 30" (762mm)

Replacement Jaws & Strap Set 36" (915mm)

Bolt Cutters - High Tensile, Forged Handles

Part No	Total Length	Max. Cutting Capacity	Pack
EC-EFBC14	14" (355mm)	3/16" / 5.0mm	16
EC-EFBC18	18" (460mm)	1/4" / 6.4mm	8
EC-EFBC24	24" (610mm)	5/16" / 7.9mm	6
EC-EFBC30	30" (762mm)	3/8" / 9.5mm	4
EC-EFBC36	36" (915mm)	7/16" / 11.1mm	3
EC-EFBC42	42" (1070mm)	1/2" / 13mm	2

Centre Cut



High tensile - for cutting hard materials up to 50HRC. Centre cut, arm adjusted bolt cutters with solid forged handles for maximum strength - every pound of force applied is amplified to produce 80lbs (36kg) of force between the jaws. To maximise safety the built in stops will yield rather than break, whilst the drop forged jaws are machined to precise specifications for a resilient body and rigid cutting edge

Part No

EC-EFBC14RH

EC-EFBC18RH

EC-EFBC24RH

EC-EFBC30RH

EC-EFBC36RH

EC-EFBC42RH

Spares For Boltcutters - Forged Handles

Replacement Head - 14" (355mm)

Replacement Head - 18" (460mm)

Replacement Head - 24" (610mm)

Replacement Head - 30" (762mm)

Replacement Head - 36" (915mm)

Replacement Head - 42" (1070mm)

COLD CHISELS

Flat Chisels

For general cutting and chipping of metals, and for shaping, facing and cutting of stonework



Part No	Length	Blade Width	Octagon Dia.	Pack Qty
EC-CB28G	150mm (6")	6.35mm (1/4")	6.35mm (1/4")	10
EC-CB48E	150mm (6")	9.5mm (3/8")	9.5mm (3/8")	10
EC-CB70H	205mm (8")	12.7mm (1/2")	12.7mm (1/2")	10
EC-CB72F	250mm (10")	12.7mm (1/2")	12.7mm (1/2")	10
EC-CB88R	150mm (6")	15.9mm (5/8")	12.7mm (1/2")	10
EC-CB92N	250mm (10")	15.9mm (5/8")	12.7mm (1/2")	10
EC-CB110T	205mm (8")	19mm (3/4")	15.9mm (5/8")	10
EC-CB113V	300mm (12")	19mm (3/4")	15.9mm (5/8")	10
EC-CB116M	450mm (18")	19mm (3/4")	15.9mm (5/8")	5
EC-CB150E	205mm (8")	25.4mm (1")	22.2mm (7/8")	5



Crosscut Chisels

For cutting narrow slots or cuts.



Part No	Length	Blade Width	Octagon Dia.	Pack Qty
EC-CB534A	150mm (6")	6.35mm (1/4")	12.7mm (1/2")	10



Eclipse Professional Cold Chisels have been upgraded to chrome vanadium. This is both better quality and harder wearing, so needs re-sharpening less often, and is also even more resistant to mushrooming after prolonged use.

Floorboard Chisel

For cutting floorboard tongues before lifting



Part No	Length	Blade Width	Octagon Dia.	Pack Qty
EC-CB770K	230mm (9")	56mm (2 1/4")	17.5mm (11/16")	5

Concrete Point Chisels

For breaking up concrete



Part No	Length	Blade Width	Octagon Dia.	Pack Qty
EC-CB292R	250mm (10")	4mm (5/32")	15.9mm (5/8")	10
EC-CB313P	300mm (12")	4.8mm (3/16")	19mm (3/4")	10
EC-CB353G	300mm (12")	6.35mm (1/4")	25mm (1")	5

Guarded Chisels

Hand guarded cold chisels fitted with strong guard designed to withstand the heaviest hammer blow and so protect the user's hand from injury.



Part No	Type	Length	Blade Width	Hexagon Dia.	Pack Qty
EC-22-208R	Flat	205mm (8")	19mm (3/4")	15.9mm (5/8")	5
EC-22-210R	Flat	250mm (12")	25.4mm (1")	22.2mm (7/8")	5
EC-22-310R	Concrete Point	250mm (12")	4mm (5/32")	25mm (1")	5
EC-22-410R	Plugging	250mm (10")	6.35mm (1/4")	22.2mm (7/8")	5

Plugging Chisel

For cutting out mortar from between bricks, to allow removal without breaking the brick



Part No	Length	Blade Width	Octagon Dia.	Pack Qty
EC-CB827V	250mm (10")	6.35mm (1/4")	15.9mm (5/8")	5

LOCKING PLIERS LOCKING C-CLAMPS



A range of top quality locking pliers and locking C-Clamps for the professional user

Screw adjusts to fit the work piece and exerts a pressure that is maintained even after repetitive use

Heat treated, wear resistant serrated and hardened jaws provide a firm grip from any angle



Guarded release trigger protects against accidental release whilst also enabling the tool to be quickly unlocked when required

Body and jaws on all locking pliers made from high grade chrome molybdenum steel to withstand heavy duty working conditions, such as welding and hammer strikes

Retail Packaging



Locking Pliers - Typical Applications

Part No.	Heating & A/C	Welding	Plumbing	Automotive	Electrical	Woodworking
EC-E7R EC-E10R	Clamping, crimping	Clamping flat, square & hex surfaces	Non slip pipe wrench, portable vice, twisting wire	Clamping, removing bolts	Portable vice, twisting wire	Portable vice, pulling out nails
EC-E10CR	Clamping, crimping	Clamping round surfaces	Non slip pipe wrench, portable vice, twisting wire	Clamping, removing bolts	Portable vice, screwdriver lever	Portable vice, pulling out nails
EC-E5WR EC-E7WR EC-E10WR	Clamping, crimping, wire cutting	Clamping round surfaces	Non slip pipe wrench, portable vice, cutting & twisting wire	Clamping, removing bolts	Portable vice, screwdriver lever, cutting & twisting wire	Portable vice, pulling out nails, cutting wire
EC-E6LN	Clamping, crimping, wire cutting	Clamping in difficult-to-reach spaces	Repairing faucets	Removing brake springs & clips, general clamping	Bending & cutting wire	Pulling nails & staples
EC-E6SP EC-E11SP	Clamping welding supports	Clamping welding supports	Temporary pipe hanger	Sheet metal repair work	-	Clamping long reach, delicate woodworking work pieces
EC-E6R EC-E11R	Clamping welding supports	Clamping welding supports	Temporary pipe hanger	Sheet metal repair work	-	Clamping long reach woodworking work pieces
EC-E8R	-	Holding sheet metal during bending, forming & crimping	-	-	-	-
EC-E9R	-	Accurately aligning round & square shaped tubing	-	-	-	-

LOCKING JAW PLIERS & LOCKING C-CLAMPS

STRAIGHT JAW

Part No.	Size	Maximum Jaw Capacity	Pack
EC-E7R	175mm (7")	34mm (1 5/16")	5
EC-E10R	250mm (10")	45mm (1 3/4")	5



Straight jaws are ideal for use with flat, square and hex workpieces



CURVED JAW

Part No.	Size	Maximum Jaw Capacity	Pack
EC-E10CR	250mm (10")	45mm (1 3/4")	5



Designed for gripping and clamping round surfaces

CURVED JAW with wire cutter

Part No.	Size	Maximum Jaw Capacity	Pack
EC-E5WR	125mm (5")	32mm (1 1/4")	5
EC-E7WR	175mm (7")	34mm (1 1/2")	5
EC-E10WR	250mm (10")	34mm (1 7/8")	5



Designed for gripping and clamping round surfaces. Incorporates a wire cutter



LONG NOSE with wire cutter

Part No.	Size	Maximum Jaw Capacity	Pack
EC-E6LN	150mm (6")	51mm (2")	5



Particularly suited for clamping and tightening bolts in confined spaces. Also ideal for precision work. Incorporates a wire cutter

PRODUCT TESTING

■ **Rockwell Hardness Testing**

The Rockwell method measures the permanent depth of indentation produced by a force/load on an indenter.

■ **Torsion Testing**

A Torsion Test is performed to determine material behaviour in torsional loading or rotational torque loading.

■ **Tensile Compress Testing**

The Tensile Compression Test is an evaluation of the mechanical behavior of a sample under conditions of tension and compression can be performed to provide basic material property data that is critical for component design and service performance assessment.



Rockwell Hardness Testing



Torsion Testing



Tensile Compress Testing

LOCKING JAW PLIERS & LOCKING C-CLAMPS

LOCKING PINCH OFF PLIERS

Part No.	Size	Maximum Jaw Capacity	Pack
EC-ERR	175mm (7")	6mm (1/4")	5



SPECIAL ORDER ONLY

Provides a temporary, hands free seal on tubing

LOCKING SHEET METAL TOOL

Part No.	Maximum Jaw Capacity	Pack
EC-E8R	78mm (3 1/8")	5



Grips and locks on to sheet metal when bending, forming, and crimping



LOCKING C-CLAMPS with swivel pads

Part No.	Size	Maximum Jaw Capacity	Pack
EC-E6SP	150mm (6")	44mm (1 3/4")	5
EC-E11SP	275mm (11")	80mm (3 1/8")	5



The wide opening jaws are designed to reach around and grip awkward shapes whilst the swivel pad allows you to apply even pressure, even on angled work surfaces.

LOCKING C-CLAMPS with regular tips

Part No.	Size	Maximum Jaw Capacity	Pack
EC-E6R	150mm (6")	44mm (1 3/4")	5
EC-E11R	275mm (11")	80mm (3 1/8")	5



The wide opening jaws are designed to reach around and grip awkward shapes.



LOAD TEST RESULTS

ECLIPSE

ASME Specification

The American Society of Mechanical Engineers

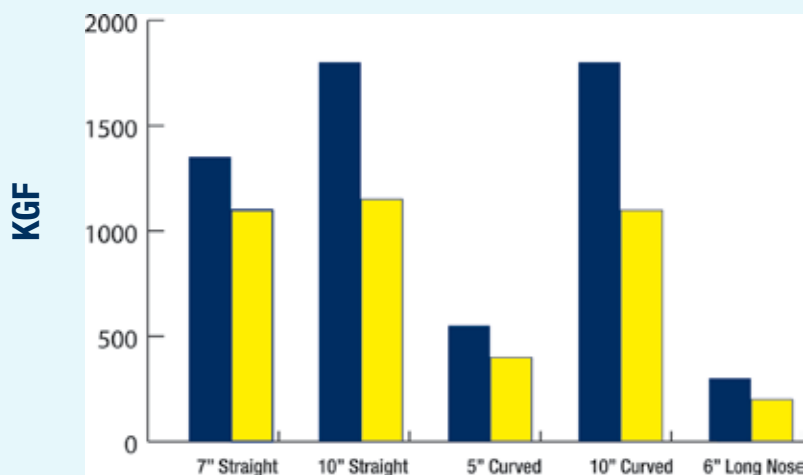

MECHANICS' VICES, SPARES & ACCESSORIES
WOODWORKING VICES & G-CLAMPS
ONE HANDED BAR CLAMPS
SCREW CLAMPS
SASH CLAMPS
MAGNETIC WELDING TOOLS
MAGNETIC CHUCKS



Workholding Range - Average Clamping Forces

Range	Average Clamping Force	Main Tasks
VICES		
Mechanics' Vices	4,500lbs - 10,100lbs (2,040kg - 4,580kg)	General metalworking applications
Quick Release Woodworking Vices	1,900lbs (860kg)	Holding large pieces of wood for cutting and gluing
Plain Screw Woodworking Vices	1,900lbs (860kg)	Holding large pieces of wood for cutting and gluing
CLAMPS		
T-Bar Clamps	2,200lbs (1,000kg)	Clamping heavy pieces of furniture when gluing
Sash Clamps	1,100lbs (500kg)	Clamping heavy pieces of furniture when gluing
Clamp Heads	Light Duty (depends on timber used)	Low cost alternative to sash clamps
G Clamps (Extra heavy duty)	Frame Proof Loads 3,300lbs - 4,500lbs (1500kg - 2050kg)	Heavy duty fabrication and engineering tasks
G Clamps (Heavy duty)	Frame Proof Loads 660lbs - 1,700lbs (300kg - 770kg)	Multi-purpose - generally woodworking & metalworking
Screw Clamps (Mid range)	660lbs (300kg)	Lightweight wood/metal clamping
One Handed Bar Clamp & Spreaders	150kg	A 'third hand'

VICES

For general metalworking applications

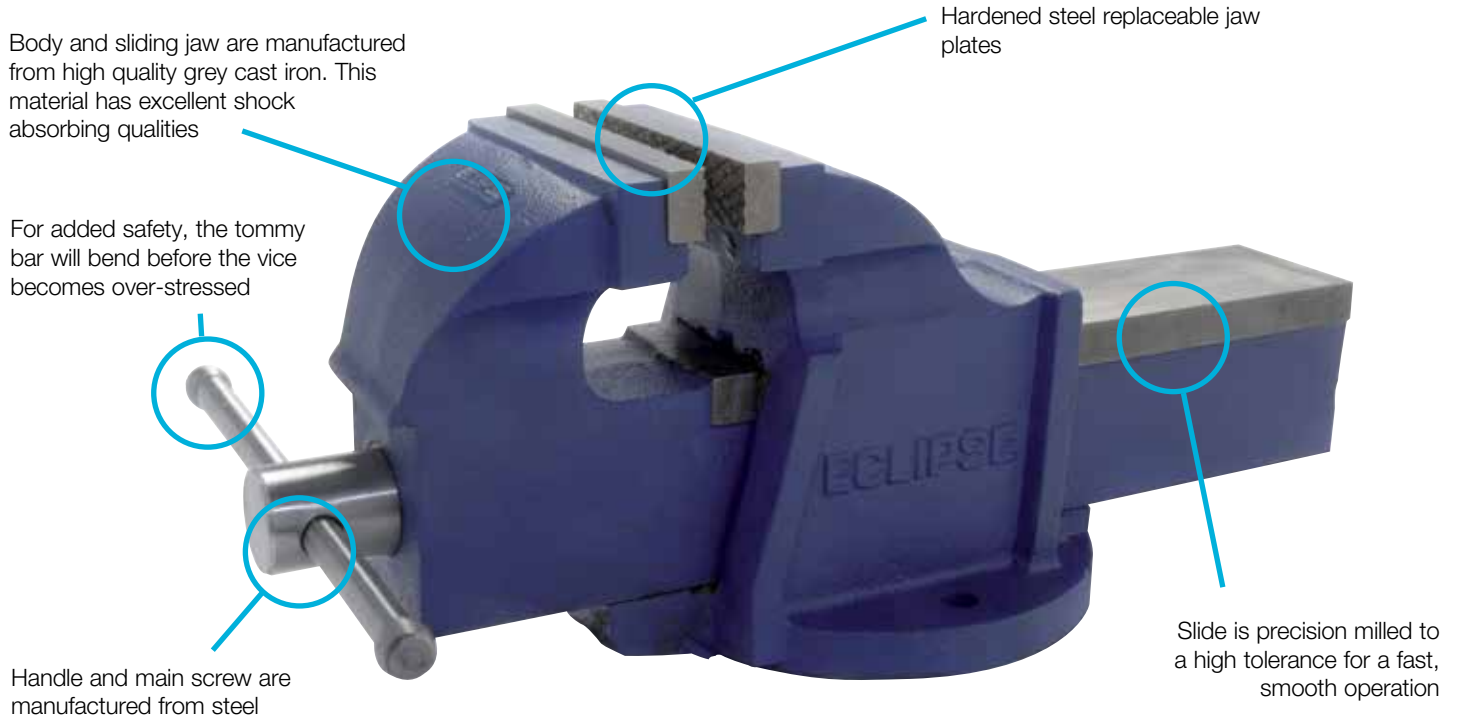

Mechanics' Vices

The body and sliding jaw are manufactured from high quality grey cast iron, which has excellent shock absorbing qualities. The precision milled slide ensures a fast, smooth operation, whilst the fused tommy bar will bend before the vice can become over-stressed. Includes hardened steel replaceable jaws and fixing holes for bench mounting

Part No	Jaw Width	Throat Depth (mm)	Opening (mm)	Clamping Force (kN)	Net Weight (kg)	Qty per pallet
EC-EMV1	3"/ 75mm	48	82	20	4.8	144
EC-EMV3	4"/ 100mm	63	109	25	9.3	100
EC-EMV5	5"/ 125mm	73	136	30	15.8	40
EC-EMV6	6"/ 150mm	86	168	35	24.2	36
EC-EMV8	8"/ 200mm	103	208	45	38.1	100

Replacement Jaw Plates with Screws (pair)

Part No	Description	Pack Qty
EC-EMV-1JPS	For use with EC-EMV1	1
EC-EMV-3JPS	For use with EC-EMV3	1
EC-EMV-5JPS	For use with EC-EMV5	1
EC-EMV-6JPS	For use with EC-EMV6	1
EC-EMV-8JPS	For use with EC-EMV8	1



VICES

Swivel Bases

For use with Eclipse Mechanics' Vices



Includes three mount holes for attaching to a workbench.

Part No	Size	For use with
EC-EMV-SB1	Swivel Base for 3" (75mm) Vice	EC-EMV1
EC-EMV-SB3	Swivel Base for 4" (100mm) Vice	EC-EMV3
EC-EMV-SB5	Swivel Base for 5" (125mm) Vice	EC-EMV5
EC-EMV-SB6	Swivel Base for 6" (150mm) Vice	EC-EMV6
EC-EMV-SB8	Swivel Base for 8" (200mm) Vice	EC-EMV8

Soft Jaws

For use with Eclipse Mechanics' Vices

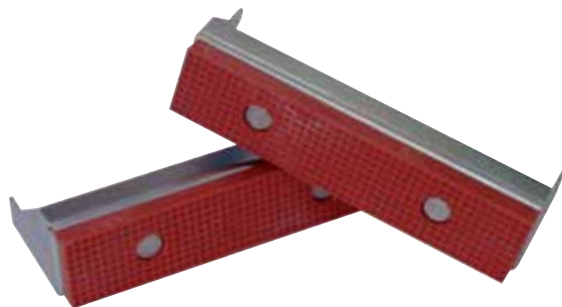

A range of high quality fibre grips for use with Eclipse Mechanics' Vices. Prevents damage to workpieces with soft or polished surfaces. Supplied in pairs

Part No	Size	For use with	Pack Qty
EC-EFG1	3" (75mm)	EC-EMV1	10
EC-EFG3	4" (100mm)	EC-EMV3	10
EC-EFG5	5" (128mm)	EC-EMV5	10
EC-EFG6	6" (150mm)	EC-EMV6	10
EC-EFG8	8" (200mm)	EC-EMV8	10

Quick Release Woodworking Vices



Quick release trigger opens and closes the vice quickly without using the mainscrew. Fitted with an adjustable front stop – or dog – that gives an additional clamping facility when used with a bench stop, to provide a normal vice and a tail vice in one tool. To increase safety, the fused tommy bar will bend before the vice can become over-stressed

Part No	Jaw Width	Throat Depth (mm)	Opening (mm)	Net Weight (kg)	Qty per pallet
EC-EWWQR7	7"/ 178mm	80	202	9.4	60

Plain Screw Woodworking Vices

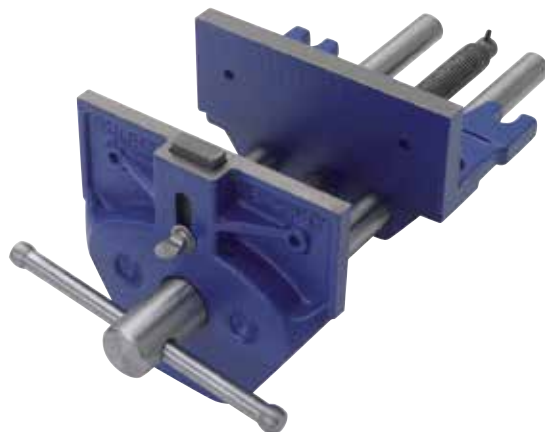

Plain screw mechanism works through a separate unbreakable nut housed beneath the body seating, to ensure the constant alignment of the screw mechanism. Precision machined grey cast iron body and front to ensure a smooth, parallel action. Fitted with an adjustable front stop – or dog – that gives an additional clamping facility when used with a bench top, to provide a normal vice and a tail vice in one tool. To increase safety, the fused tommy bar will bend before the vice can become over-stressed

Part No	Jaw Width	Throat Depth (mm)	Opening (mm)	Net Weight (kg)	Qty per pallet
EC-EWWPS7	7"/ 178mm	80	202	9.4	60

CLAMPS

For woodworking & metalworking applications

Steel swivel shoe applies an even pressure, even on angled work surfaces

Fast action twin start rolled acme thread

Guaranteed unbreakable malleable iron frame

Tommy bar will bend before the frame can become over-stressed

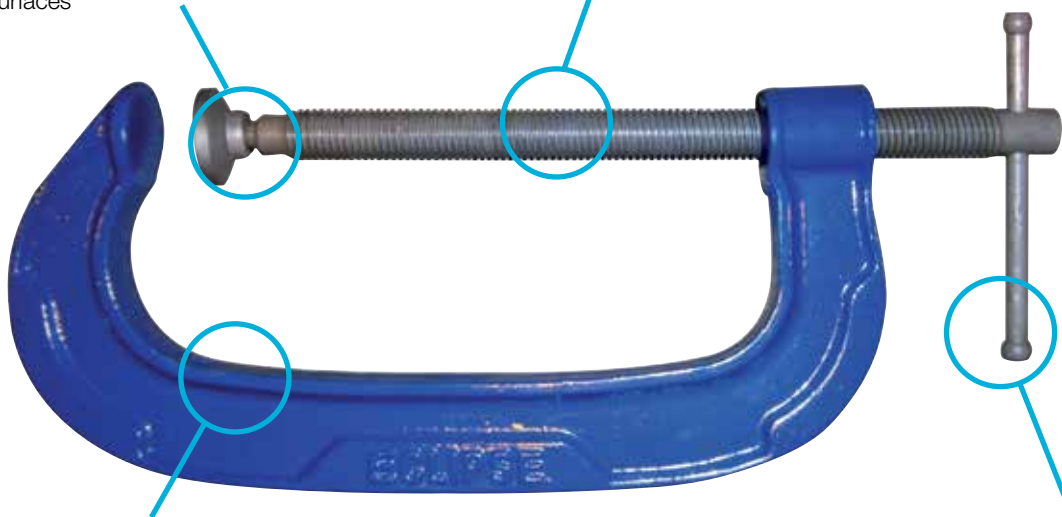

G Clamps - Heavy Duty



Average clamping force of 300 – 800kg (660 – 1760lbs). Guaranteed unbreakable malleable iron frame with a fast action twin start rolled acme thread. The steel swivel shoe applies an even pressure, even on angled surfaces, whilst the tommy bar will bend before the frame can become over-stressed.

Part No	Clamping Capacity	Frame Proof Loads	Pack
EC-E20-3	3" (75mm)	1000lbs / 455kg	6
EC-E20-4	4" (100mm)	1200lbs / 545kg	6
EC-E20-6	6" (150mm)	1400lbs / 636kg	6
EC-E20-8	8" (200mm)	1700lbs / 773kg	2
EC-E20-10	10" (250mm)	2000lbs / 909kg	2
EC-E20-12	12" (300mm)	2500lbs / 1136kg	2



CLAMPS

One Handed Bar Clamps & Spreaders

Quick release trigger enables the clamp to be quickly positioned and released, whilst the jaw release clip mechanism allows the jaw to be removed and re-attached to the other end of the bar, thus converting the clamp into a spreader. The carbon steel bar and reinforced nylon body make it both tough and durable, whilst the ergonomically-designed, soft feel pistol grip handle fits easily into the hand. In addition, the toe-in feature means that, when fully closed, the jaws only meet at the top, thus providing an even clamping force across the whole depth of the workpiece. Non-marring pads firmly grip and protect the workpiece



Part No	Clamping Capacity	Spreading Capacity (Min)	Spreading Capacity (Max)	Jaw Depth	Pack Qty
EC-EOHBC6	6" (150mm)	6 5/8" (168mm)	13 3/8" (340mm)	3 3/8" (85mm)	20
EC-BCTP300*	6" (150mm)	6 5/8" (168mm)	13 3/8" (340mm)	3 3/8" (85mm)	5
EC-EOHBC12	12" (300mm)	6 5/8" (168mm)	19 1/2" (495mm)	3 3/8" (85mm)	12
EC-EOHBC18	18" (450mm)	6 5/8" (168mm)	25 3/8" (645mm)	3 3/8" (85mm)	12
EC-EOHBC24	24" (600mm)	6 5/8" (168mm)	31 1/2" (800mm)	3 3/8" (85mm)	12
EC-EOHBC36	36" (900mm)	6 5/8" (168mm)	43 1/2" (1105mm)	3 3/8" (85mm)	12

**EC-BCTP300 IS TWO PACK OF 300MM CLAMPS

F Clamps



DIN5117 standard clamps with an average clamping force of 300kg (660lbs). The sliding head quickly sets the clamp to the required capacity, whilst the serrated grooves on the corrosion resistant nickel plated bar prevent slippage in use. The cast iron malleable heads offer maximum strength and the wooden handle provides a firm and comfortable grip.

Part No	Clamping Capacity	Clamping Depth	Pack
EC-SCR8	8" / 200mm	120mm / 4 3/4"	10
EC-SCR12	12" / 300mm	120mm / 4 3/4"	10
EC-SCR16	16" / 400mm	120mm / 4 3/4"	10
EC-SCR24	24" / 600mm	120mm / 4 3/4"	10
EC-SCR32	32" / 800mm	120mm / 4 3/4"	6

CLAMPS

Sash Clamps

Sash clamps have an average clamping force of 500kg (1100lbs). The ductile head and slide are guaranteed unbreakable, whilst the steel bar offers maximum tensile and yield strength. The slightly tapered jaws enable perfectly parallel clamping and the fast action rolled thread applies pressure quickly and smoothly to the workpiece



Part No	Maximum Clamping Capacity / Type	Bar Length	Pack
EC-ESC24	24" (600mm)	30" (760mm)	6
EC-ESC30	30" (760mm)	36" (915mm)	6
EC-ESC36	36" (915mm)	42" (1070mm)	6
EC-ESC42	42" (1070mm)	48" (1220mm)	6
EC-ESC48	48" (1220mm)	54" (1370mm)	6

T-Bar Clamps



Average clamping force of 1000kg (2200lbs). T section beam allows for maximum rigidity and higher clamping forces. The drilled feet in the fixed head enable the clamp to be mounted to a workbench. The ductile head and slide are guaranteed unbreakable, whilst the steel bar offers maximum tensile and yield strength. The slightly tapered jaws enable perfectly parallel clamping and the fast action rolled thread applies pressure quickly and smoothly to the workpiece

Part No	Maximum Clamping Capacity	Bar Length	Pack
EC-ETBR42	42" (1070mm)	48" (1220mm)	4
EC-ETBR48	48" (1220mm)	54" (1370mm)	4
EC-ETBR54	54" (1370mm)	60" (1525mm)	4

MAGNETIC WELDING TOOLS

Magnetic Variable Clamp

Part No	Length mm	Height mm	Width mm	Weight (kg)	Pull Force (kg)
EC-E952	195	200	11	0.49	20



NB Dimensions with arm set at 90°

Fast accurate holding of ferrous sheets and tubes for welding and assembly work

Heavy Duty Variable Clamp

Part No	Length mm	Height mm	Width mm	Weight (kg)	Pull Force (kg)
EC-E974	140	140	35	1.40	40



Clamp components during welding, fabrication and assembly. Powerful 40kg clamping force, enabling larger components to be clamped with ease

90° Fixed Magnetic Clamps

Part No	Length mm	Height mm	Width mm	Weight (kg)	Pull Force (kg)
1 EC-E971	140	140	35	1.40	40
2 EC-E972	225	225	22	2.20	75
3 EC-E973	300	300	35	4.70	200



Two magnetic faces in a rigid 90° angle for jiggling on sheets, pipes and tubes. A fast and cost effective means of clamping components rigid at 90° angles during fabrication, assembly and weld preparation applications

Magnetic Holdfasts

Part No	Dia mm	Height mm	Fixing Holes PCD	No. of Holes	Weight (kg)	Pull Force (kg)
EC-E939	44.5	44.5	31.75	2 x M8	0.6	20
EC-E940	54.0	49.2	38.1	2 x M8	1.0	40
EC-E941	70.0	64.5	50.8	2 x M8	2.0	88
EC-E942	101.6	74.6	69.05	3 N/A	4.7	183



Supplied with screw release handle. Can be built into workholding, handling and assembly fixtures to provide a high clamping force and positive grip

Heavy Duty Magnetic Clamp

Part No	Length mm	Height mm	Width mm	Weight (kg)	Pull Force (kg)
EC-E954	14	82	120	0.3	10
EC-E955	18	102	160	0.7	15



Hold workpieces at an exact 45° or 90° angle to each other. 10kg and 15kg of magnetic pull make these ideal for a range of workshop welding and holding applications

'Quick' Magnetic Clamps

Part No	Length mm	Height mm	Width mm	Weight (kg)	Pull Force (kg)
EC-E951	100.5	65.5	12	0.3	10
EC-E953	100.5	65.5	20	0.4	15

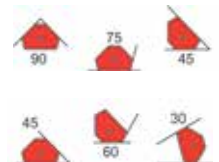

Fast and accurate holding of ferrous metals at different fixed angles. Also suitable for retrieval applications

MAGNETIC WELDING TOOLS

Magnetic Mitre Clamps

Part No	Length base face mm	Length top face mm	Height mm	Width mm	Weight (kg)	Pull Force(kg)
1 EC-923	156	66	45	43	1.36	100
2 EC-924	184	94	45	43	1.64	68

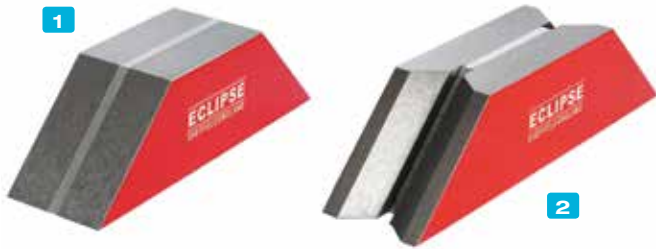

Effective and inexpensive method of clamping flat (923) or round (924) ferrous components

Magnetic Positioner

Part No	Length mm	Height mm	Width mm	Weight (kg)	Pull on flat face (kg)	Pull Force on v face (kg)
EC-922 (pair)	206	63.5	76	3.17	80	80



2 magnetic blocks connected by 2 non-magnetic steel straps. The blocks contain ferrite magnetic material. Magnetic on two faces. On / off switch located at each end

Magnetic Adjustable Links

Part No	Length mm	Height mm	Width mm	Weight (kg)	Pull Force (kg)
EC-920 SU (single unit)	60	25	29	0.35	12
EC-920 (pair)	127	25	51	0.70	12



Ferrite magnet material. Clamp components at any angle for welding and assembly applications

Magnetic Holder

Part No	Length mm	Height mm	Width mm	Weight (kg)	Pull Force (kg)
EC-E925	108	140	108	5.67	100



Provides the welder with a powerful, rigid support on flat and round components at various angles during welding and welding preparation applications. Switchable and can be partially energised to aid positioning



ULTRALIFT PLUS+
ULTRALIFT LM
ULTRALIFT TP



MAGNETIC LIFTERS

Magnetic lifters are quicker, easier and safer to use than slings, chains, hooks and grabs, and do not mark the load.

Onboard switching and permanent magnet technology mean installation and operation could not be easier and running costs are non-existent.

Access is only required to the load's top face, allowing for more efficient storage and handling.



Ultralift^{plus}+

Ultralift Plus
The world's safest lifter

Lifts up to 2000kg (flat) 800kg (round)

3 safety features:

- Locking switch handle mechanism
- Unique 'Safety Shim': pre-test any load to ensure a 3:1 safety factor
- Locking eye mechanism: magnet cannot be switched off while holding a load

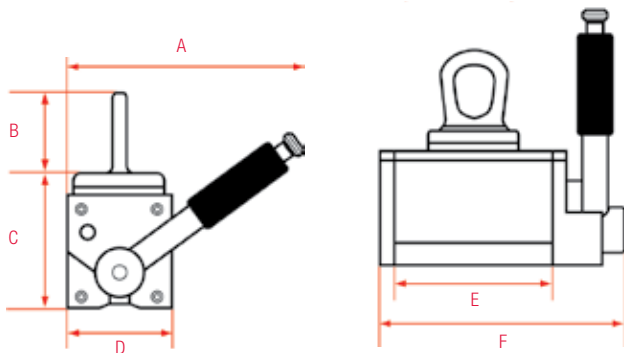

3:1 SAFETY FACTOR



The patented 'safety shim' allows pre-testing of the load to be lifted, irrespective of weight, material type, material thickness and surface condition. If the load passes a 3:1 safety factor is guaranteed

Ultralift Plus+

Part No.	Self Weight (kg)	Lifter Dimensions mm						Material Length Max. mm	Lift Specifications				
		A	B	C	D	E	F		Flat Section		Round Section		
								SWL* (kg)	Thickness Min. mm	SWL* (kg)	Diameter Max. mm		
EC-UL0125	4	152	64	74	69	101	155	1500	125	20	50	200	
EC-UL0250	11	218	94	96	92	155	214	1500	250	25	100	300	
EC-UL0500	27	266	123	128	122	224	300	1500	500	30	200	400	
EC-UL1000	63	391	140	174	176	260	359	1500	1000	45	400	450	
EC-UL2000	157	493	195	227	233	368	477	2000	2000	70	800	600	

* SWL - Safe Work Load

MAGNETIC LIFTERS

Ultralift LM

Part No.	Self Weight (kg)	Lifter Dimensions mm						Material Length Max. mm	Lift Specifications			
		A	B	C	D	E	F		Flat Section	Thickness	Round Section	Diameter
EC-LM0125	4.5	150	54	62	76	110	150	125	20	50	250	
EC-LM0250	8.5	210	76	72	90	165	200	250	25	100	300	
EC-LM0500	17.5	281	103	88	106	225	243	1500	30	200	400	
EC-LM1000	36.5	391	113	103	136	325	365	1500	45	400	450	
EC-LM2000	79	483	170	132	186	400	526	2000	70	800	600	

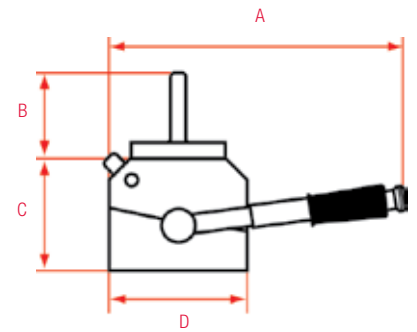

Ultralift LM

Safe, general-purpose lifting

Lifts up to 2000kg (flat)

800kg (round)

Locking switch handle mechanism

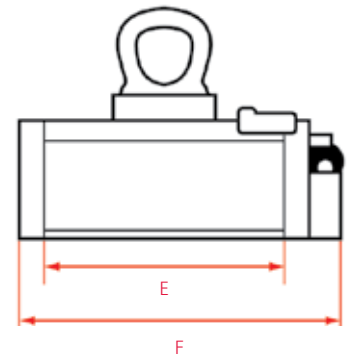

Ultralift TP

Part No.	Self Weight (kg)	Lifter Dimensions mm						Lift Specifications											
		A	B	C	D	E	F	Material Thickness											
								5mm		6mm		8mm		10mm					
								SWL (kg)	Length Max. mm	SWL (kg)	Length Max. mm	SWL (kg)	Length Max. mm	SWL (kg)	Length Max. mm				
EC-TP150	8	181	52	74	100	150	202	75	1500	100	1500	150	1500	200	1500				
EC-TP300	15	181	52	74	100	300	352	150	2000	200	2000	300	2000	400	2000				

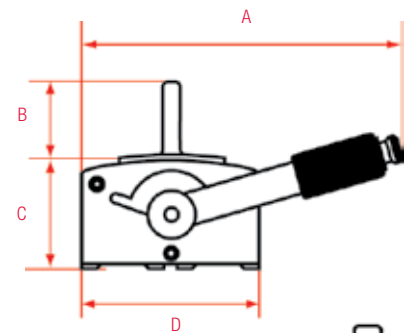

Ultralift TP

Thin plate lifter

Lifts up to 400kg (flat)

Specifically designed for the safe lifting of thin plate and pressings, it can lift single sheets from the tops of stacks

Locking switch handle mechanism

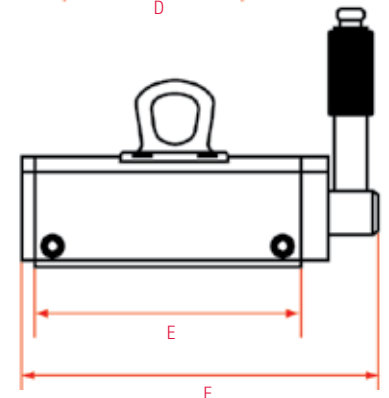

ALUMINIUM PIPE WRENCHES ADJUSTABLE WRENCHES



LEADER PATTERN ALUMINIUM PIPE WRENCHES

For manipulating large capacity threaded pipe joints

Induction hardened contra directional jaw teeth ensure long lasting positive grip

Handy scale markings on the hook jaw for quick adjustments to pipe dimensions.

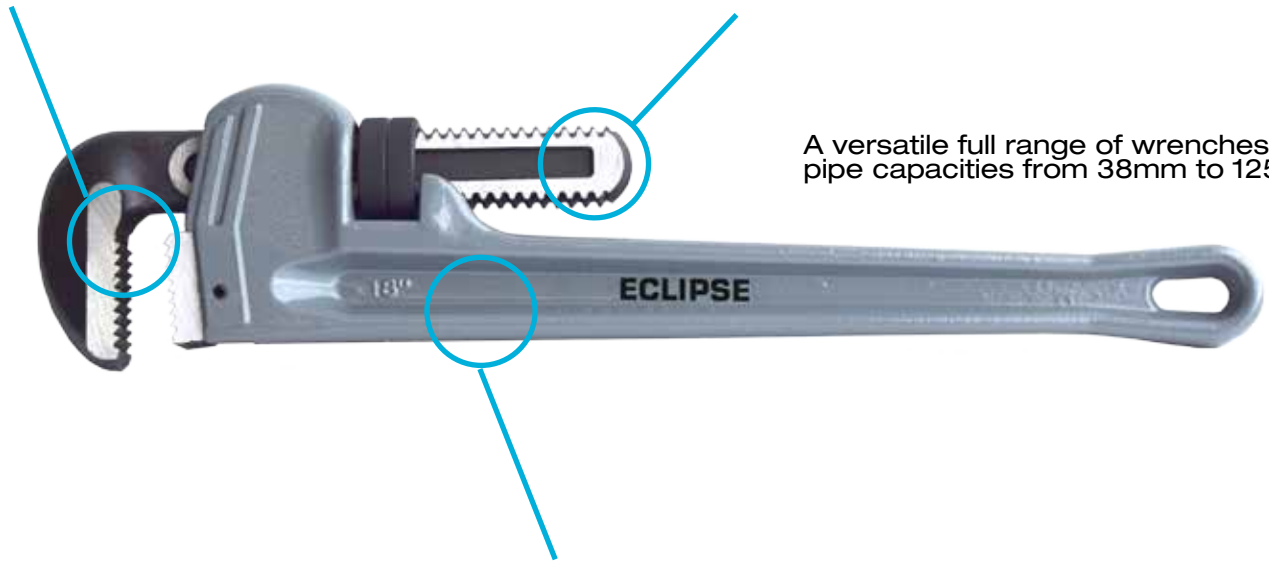

A versatile full range of wrenches with pipe capacities from 38mm to 125mm

The frame & handle are a one piece light-weight aluminium casting.

Leader Pattern Aluminium Pipe Wrenches



Ideal for manipulating large capacity threaded pipe joints and tightening or loosening threaded collars on pipe work, nuts & bolts.

Part No	Length (when open)	Pipe Capacity	Pack
EC-EAPW10	10" (250mm)	1 1/2" (38mm)	6
EC-EAPW12	12" (300mm)	2" (50mm)	6
EC-EAPW14	14" (350mm)	2" (50mm)	6
EC-EAPW18	18" (450mm)	2 1/2" (63mm)	4
EC-EAPW24	24" (600mm)	3" (75mm)	2
EC-EAPW36	36" (910mm)	5" (125mm)	4

WRENCHES & PIPE VICES

Adjustable Wrenches

Part No	Description	Jaw Opening	Pack Qty
EC-ADJW6	6" (150mm)	1 1/8" (27mm)	5
EC-ADJW8	8" (200mm)	1 1/2" (33mm)	5
EC-ADJW10	10" (250mm)	1 3/4" (38mm)	5
EC-ADJW12	12" (300mm)	1 7/8" (45mm)	5



The adjustable wrench can be used to tighten large nuts and bolts, whilst the metric scale laser etched onto the jaw ensures fast setting of the tool. The rust resistant lacquer increases the product life and the ergonomic soft feel sleeve gives maximum comfort and grip.



Adjustable Wrenches - Extra Wide Jaws

Part No	Description	Jaw Opening	Pack Qty
EC-ADJW6WJ	6" (150mm)	1 1/8" (34mm)	6
EC-ADJW8WJ	8" (200mm)	1 1/2" (38mm)	6
EC-ADJW10WJ	10" (250mm)	2" (50mm)	5
EC-ADJW12WJ	12" (300mm)	2 3/8" (60mm)	5



Ideal for use in plumbing, installation and automotive tasks. Not only does the extra wide jaw opening increase versatility, but the super thin head means that the wrench can be used in confined spaces. In addition, the throat depth is deeper than standard adjustable wrenches and the head is angled to offer maximum speed and efficiency. Soft grip handle for added comfort.

Adjustable Wrenches - Standard Handle

Part No	Length	Jaw Opening	Pack Qty
EC-ADJW6S	6" (150mm)	1" (24mm)	5
EC-ADJW8S	8" (200mm)	1 1/8" (30mm)	5
EC-ADJW10S	10" (250mm)	1 1/2" (37mm)	5
EC-ADJW12S	12" (300mm)	1 3/4" (43mm)	5
EC-ADJW15S*	15" (375mm)	1 7/8" (47mm)	2

* Ring spanner not included

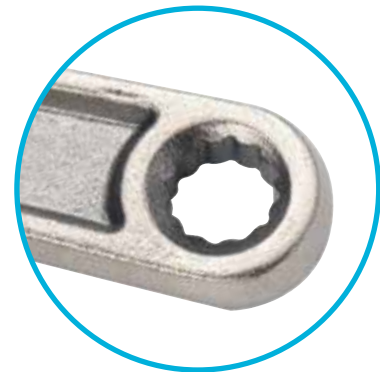

The extra wide jaw can be used to tighten large nuts and bolts, whilst the metric scale laser etched onto the jaw ensure fast setting of the tool. The rust resistant lacquer increases the product life, whilst the ergonomic handle includes a ring spanner.

**RIVETERS
THREADED INSERT
SETTING TOOLS
SPARES
KITS
RIVETS**

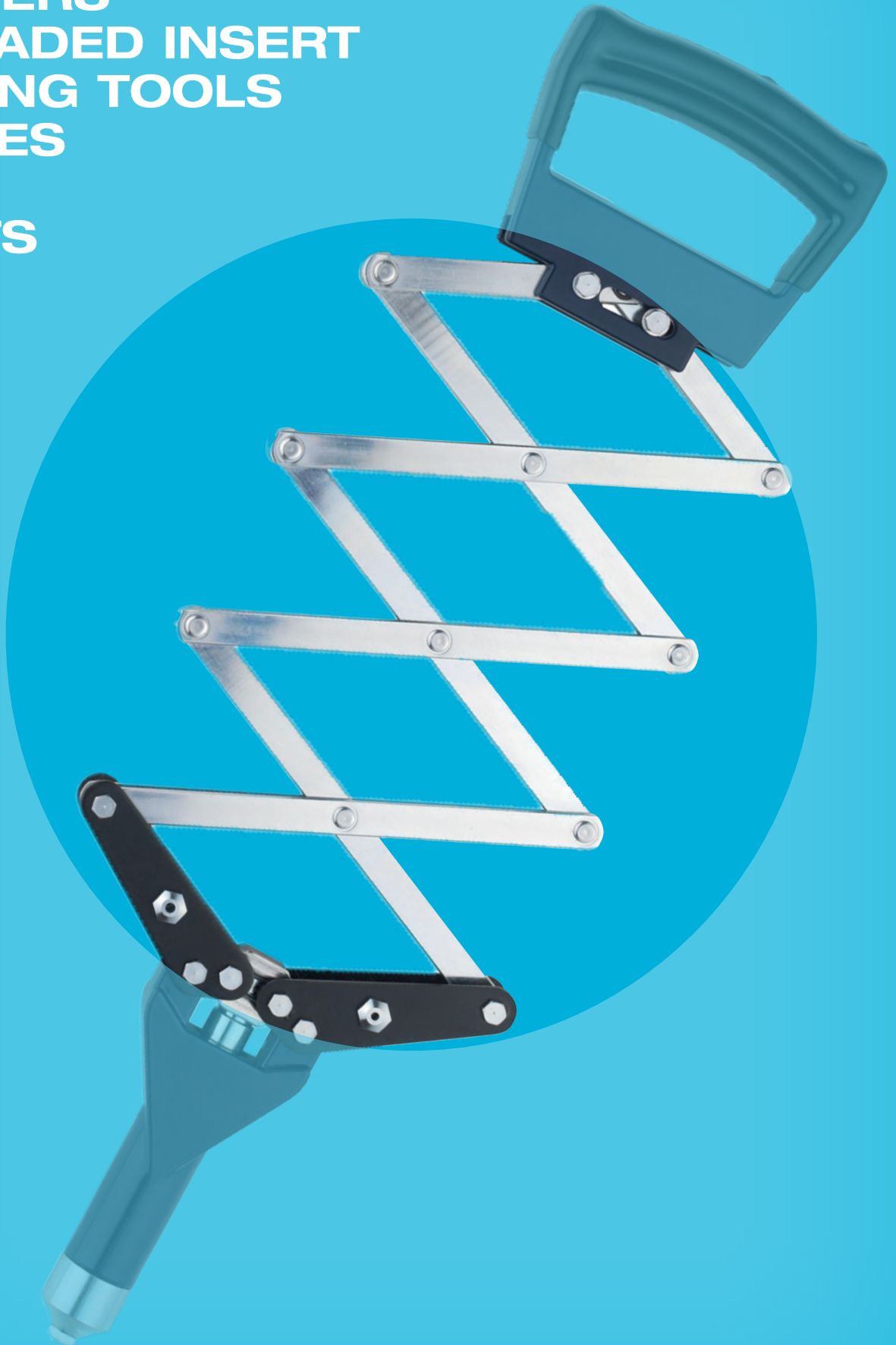

RIVETERS

Heavy Duty Lazy Tong Riveter

Part No	Description	For use with Rivet Sizes	Pack
EC-2750HD	Heavy Duty Lazy Tong	3mm (1/8") 4mm (5/32") 5mm (3/16") 6.4mm (1/4")	1



A fixed head riveter ideal for use with stainless steel rivets up to 6.4mm. Can be used one handed, enabling better control of the work piece. Useful on vehicle maintenance, agricultural projects and construction.



Lazy Tong Riveter

Part No	Description	For use with Rivet Sizes	Pack
EC-2750	Lazy Tong	3mm (1/8") 4mm (5/32") 5mm (3/16")	1



This powerful and versatile tool has the advantage of being operated with one hand, providing no loss in efficiency. Useful on vehicle maintenance, agricultural projects and construction.

Long Arm Riveter

Part No	Description	For use with Rivet Sizes	Pack
EC-2760	Long Arm	4mm (5/32") 5mm (3/16") 6mm (1/4")	1



The long armed riveter reduces the minimum the effort required to set rivets up to 6mm. Probably the most powerful industrial hand riveter available today. Ideal for boat building and coachwork, agricultural machine maintenance, etc. Supplied with 4 interchangeable noses

Heavy Duty Long Nose Riveter

Part No	Description	For use with Rivet Sizes	Pack
EC-2720	Heavy Duty Long Nose	3mm (1/8") 4mm (5/32") 5mm (3/16")	1



A versatile variation of the 2730, with extra long nose to facilitate access in recessed situations such as corrugated sheet. Supplied with 4 interchangeable noses

Heavy Duty Riveter

Part No	Description	For use with Rivet Sizes	Pack
EC-2730	Heavy Duty	3mm (1/8") 4mm (5/32") 5mm (3/16")	1



The market leading professional heavy duty riveter, best suited to engineering and maintenance projects. Supplied with 3 interchangeable noses

Spare Nose Kits

Part No	Description	For use with rivet sizes
1 EC-2738A	Kit 1-5x72HD12A	3mm (1/8")
2 EC-2738B	Kit 2-5x72HD13A	4mm (5/32")
3 EC-2738C	Kit 3-5x72HD14	5mm (3/16")

for use with 2750HD

EC-2738A-HD	Spare Nose Kit - 5 x 3mm
EC-2738B-HD	Spare Nose Kit - 5 x 4mm
EC-2738C-HD	Spare Nose Kit - 5 x 5mm
EC-2738D-HD	Spare Nose Kit - 5 x 6mm

for use with 2760

EC-2768A	Kit 4-1 each 72LA12 72LA13A (for aluminium) 72LA13S (for steel) 72LA14	4mm (5/32") 5mm (3/16") 5mm (3/16") 6mm (1/4")
----------	---	---



Riveter Repair Kits

Part No	Description	Pack
EC-2729	Repair kit for 2720	1
EC-2739	Repair kit for 2730/2770	1
EC-2759	Repair kit for 2750	1
EC-2769	Repair kit for 2760	1



THREADED INSERT SETTING TOOLS & KITS



Threaded Insert Setting Tool

Part No
1 EC-2743

Description
This thin sheet setting tool has been designed to enable threaded nut inserts to be set easily by hand. Invaluable to maintenance engineers for on-the-spot repairs. Supplied in storage wallet complete with 4mm, 5mm, 6mm and 8mm nose bushes and mandrels

Threaded Insert Setting Tool Kit

Part No
2 EC-2745

Description
As the 2743 but supplied with additional 4mm, 5mm, 6mm and 8mm threaded nutserts. Housed in a compact tool box for easy storage

Threaded Insert Nose Bush / Mandrel Conversion Kit

Part No	Description	Pack
EC-CK4	4mm Conversion Kit to suit EC-2743 & EC-2745	10
EC-CK5	5mm Conversion Kit to suit EC-2743 & EC-2745	10
EC-CK6	6mm Conversion Kit to suit EC-2743 & EC-2745	10
EC-CK8	8mm Conversion Kit to suit EC-2743 & EC-2745	10



- Designed for the quick, manual insertion of permanent load bearing threads in materials from 0.20" to 0.128"
- Simple set up and easy uniform stroke allows a nutsert to be set in thin sheet materials without causing surface damage
- A comprehensive range of conversion kits are available

Product Benefits

- One side application
- Flush mounting
- Permanent thread
- Moisture resistant
- Cost effective
- Strong
- Rapid
- Vibration resistant
- Portable

Spare Jaw Kits

Part No	Description
EC-2738	Pack of 5 jaws to suit models: 2720, 2730, 2750, 2770 Part No. 72HD5A
EC-2768	Pack of 5 jaws to suit models: 2760 Part No. 72LA5

SIZE	MINIMUM	MAXIMUM
4mm	0.51mm (0.020")	1.27mm (0.050")
5mm	0.51mm (0.020")	1.27mm (0.050")
6mm	0.76mm (0.030")	1.68mm (0.066")
8mm	0.91mm (0.036")	3.25mm (0.128")

**SCRAPERS / PIN VICES /
CHUCKS & COLLETS
NUTSPINNERS & PUNCHES
COMBINATION SQUARES
COMBINATION SETS
TAP WRENCHES
ACCESSORIES**



SCRAPERS / PIN VICES / CHUCKS & COLLETS



Hand scrapers are designed for the removal of high spots on machined surfaces to give a smoother surface on slideways, bearings, cast iron surface plates and precision marking out plates. All scrapers have a soft feel handle and are made from high grade tool steel suitably hardened, to maintain a very keen cutting edge

Engineers' Scrapers

Suitable for toolroom and small engineering work

Part No	Blade Length	Cutting Edge	Pack
1 EC-96A	100mm (4")	Three Square	5
2 EC-97A	140mm (5½")	Three Square	5
EC-99A	200mm (8")	Three Square	5
3 EC-96B	100mm (4")	Flat	5
4 EC-97B	150mm (6")	Flat	5
EC-99B	200mm (8")	Flat	5
EC-96C	100mm (4")	Curved half round	5
5 EC-97C	150mm (6")	Curved half round	5
EC-97D	200mm (8")	Curved half round	5
EC-97	Set of 4 comprising Nos 97A, B, C and D	1 set	

Trammel Heads

Supplied as one pair of heads. Suitable for laying out the distance between two points and scribing arcs and circles. To be used in conjunction with any wood ofcut between ¾" to 1½" wide, minimum thickness of ⅜"

Part No	Suitable for beam sizes	Pack
10 EC-33	19 x 38mm (3/8" - 1 1/2") Thick, & 38mm (3/8") Wide	Pair

Pin Vices

Hand held tools designed for holding round materials. Hollow handle enables material greater than the overall length of the pin chuck to be used

Part No	Capacity Type	mm	Inches	Overall Length	Pack
EC-121	Chuck	0-1.0	0-0.04	75mm (3")	10
EC-122	Chuck	0.75-1.5	0.03-0.062	85mm (3½")	10
EC-123	Chuck	1.4-3.1	0.055-0.122	95mm (3¾")	10
8 EC-124	Chuck	3.1-5.00	0.122-0.196	105mm (4¼")	10
EC-120	Set of 1 each (121, 122, 123 and 124)				1 set

Pin Chuck & Replacement Collects

Part No	Overall Length mm/inches	Description	Pack
9 EC-160	65mm (2½")	Chuck with 3 collets capacity	1

Used for gripping very small drills, mainly on automatic lathes, where pin chuck does not revolve

Erector Scrapers

Part No	Overall Length	Blade Length	Cutting Edge	Pack
6 EC-256	335mm (13¼")	210mm (8¼")	Flat	5
EC-257	350mm (14")	225mm (9")	Curved	5

Suitable for large jobs or heavy engineering. Manufactured from chrome vanadium steel

Bearing Scrapers

Part No	Overall Length	Blade Length	Pack
EC-258/4	180mm (7¼")	100mm (4")	5
EC-258/6	240mm (9½")	150mm (6")	5
7 EC-258/8	290mm (11½")	200mm (8")	5

Suitable for removing high spots from bearings

NUTSPINNERS & PUNCHES

Nut Spinner - BA

Part No	Length	Size	Pack
EC-7800	150mm (6")	0 BA	6
EC-7801	150mm (6")	1 BA	6
EC-7802	150mm (6")	2 BA	6
EC-7803	150mm (6")	3 BA	6
EC-7804	150mm (6")	4 BA	6

Nut Spinner - Metric

Part No	Length	Size	Pack
EC-7840	150mm (6")	4mm	6
EC-7850	150mm (6")	5mm	6
EC-7860	150mm (6")	6mm	6
EC-7870	150mm (6")	7mm	6
EC-7880	150mm (6")	8mm	6
EC-7810	150mm (6")	10mm	6

Auto Centre Punches

Part No	Length	Operating Pressure (kg)	Range (lb)	Pack
EC-65/171R	120mm (4 11/16")	13.5-2.25	30-5	10
EC-E172	149mm (5 7/8")	22.5-6.3	50-14	1



For loosening and securing nuts particularly where spanners cannot reach or are awkward to use. Trilobular handle with tapered neck for ergonomic fit. Dual material handle for comfort in use. Integral moulded finger grips around neck to allow increased torque

For loosening and securing nuts particularly where spanners cannot reach or are awkward to use. Trilobular handle with tapered neck for ergonomic fit. Dual material handle for comfort in use. Integral moulded finger grips around neck to allow increased torque

Delivers a punch when hand pressure applied to knurled head. One handed operation, hammer should not be used. Depth of impression adjusted by turning knurled head

TAP WRENCHES & COMBINATION SQUARES



Scribers

Pocket Scriber - Available with either hardened steel or tungsten carbide points. Reversible point prevents tearing and snagging of clothing when clipped in a pocket.

Engineers Double Ended Scriber - Double ended for marking out in confined spaces such as grooves and keyways

Machinists Scriber - Designed for the machinist. For marking out in confined spaces, particularly on pre-machined workpieces.

Part No	Overall Length mm/inches	Description	Pack
1 EC-E220	89mm (3 ¹ / ₂ "	Scriber - Pocket - Hardened	10
2 EC-E222	190mm (7 ¹ / ₂ "	Scriber - Engineers - Double Ended	25
3 EC-E225	89mm (3 ¹ / ₂ "	Scriber - Pocket - Carbide Tipped	10
4 EC-E227	114mm (4 ¹ / ₂ "	Scriber - Machinists	10

Standard Bar Type Tap Wrench

Provides a comfortable and positive grip plus the sensitivity required when tapping a blind hole. Knurled locknut ensures a constant grip on the tap when in use

Part No.	mm	Capacity ISO	Square A/F BA	BSF	BSW UNC	UNF	Length mm	in	Pack
5 EC-E240	1.5-4.6	M1-M6	14-0	1/8-1/4	0-12	1/4	110/105	4 1/4	1
6 EC-E242	2.5-9.0	M4-M16	3-0	3/16-5/8	8-12	1/4-5/8	230/220	9	1

Chuck Type Tap Wrench

Stepped jaws greatly extend range of taps for each wrench. Adjustable tommy bar for tapping close to a shoulder or other obstructions. Available in normal and long reach designs

Part No	Body Length	Width	Pack
7 EC-E141 (Fixed Bar)	50mm (1 ⁷ / ₈ "	57mm (2 ¹ / ₄ "	1
8 EC-E142	65mm (2 ⁵ / ₈ "	90mm (3 ¹ / ₂ "	1
8 EC-E143	90mm (3 ⁵ / ₈ "	127mm (5"	1
9 EC-E145	165mm (6 ¹ / ₂ "	90mm (3 ¹ / ₂ "	1
9 EC-E146	245mm (10"	127mm (5"	1

Part No.	Jaw Capacities	Square A/F mm	ISO	BA	BSF	BSW UNC	UNF
7 EC-E141	Min	1	M1	14	-	1	-
	Max	2.8	M3.5	4	1/8	6	-
8 EC-E142 & EC-E145	Min	2.0	M1	14	1/8	6	-
	Max	5.0	M6	0	1/8	12	1/4
8 EC-E143 & EC-E146	Min	3.0	M4	3	3/16	8	1/4
	Max	8.0	M12	0	1/8	12	1/2

COMBINATION SQUARES & SETS

Combination Squares

Part No	Description	Pack
EC-CS150	150mm (6") Combination Square	10
EC-50-470R	300mm (12") Combination Square	10



A combination square is used for multiple measuring purposes in woodworking, stonemasonry and metalworking. Available in 150mm & 300mm Combination Squares includes a hardened stainless steel rule with metric & imperial graduations, level & scriber.

Professional Combination Square

Part No	Description	Pack
EC-CS300	300mm (12") Combination Square	10



This 300mm Professional Combination Square features a cast iron square head. Equipped with a Stainless Steel Rule 300mm/12 inch with both Metric & Imperial Graduations.

Includes Level and Scriber Hardened & Ground Slideways

Combination Set

Part No	Description	Pack
EC-50-460R	300mm (12") Combination Set	5



The 300mm Combination Set includes Centre Finder, Protractor Head and Square Head Stainless Steel Rule

Handy Scriber

Graduated in Metric and Imperial

Spirit Level and Knurled Brass Lock Nut

Made in UK

PERMANENT MAGNETS ELECTRO-MAGNETS



PERMANENT MAGNETS - MAGNET MATERIALS

ALNICO
AlNiCo

- Alnico 5 magnet material (unless stated)
- 550°C max. operating temp.
- Magnetically stable at high temperatures
- Good corrosion resistance

Cylindrical Bar Magnets

Part No	Diameter mm	Length* mm	Weight per pair (kg)	Gauss	Pack Qty (Pair)
EC-E805	6	20	0.008	1200	10
EC-E806	8	25	0.018	1200	5
EC-E807	10	30	0.035	1200	5



Sold in pairs

Rectangular Bar Magnets

Part No	Material	Width mm	Height mm	Length* mm	Weight per pair (kg)	Gauss	Pack Qty (Pair)
EC-E842	Alnico 2	15	10	50	0.220	750	2
EC-E843	Alnico 2	15	10	75	0.330	750	2
EC-E844	Alnico 5	10	5	20	0.030	1100	5
EC-E845	Alnico 5	12.5	5	40	0.040	1100	5
EC-E846	Alnico 5	15	5	60	0.130	1100	5



Sold in pairs.
North pole is indicated by a notch / dimple

Minor Magnet

Part No	Width mm	Height mm	Length mm	Pole Gap	Weight (kg)	Max Pull (kg)	Pack Qty
EC-E801	7.9	11.1	22.2	6.3	0.01	0.9	10



Button Magnets

Part No	Dia. mm	Height mm	Slot Size Min - Max mm	Hole Size	Weight (kg)	Max Pull (kg)	Pack Qty
EC-E821	12.7	9.5	4.0 - 7.2	4.4	0.006	0.7	10
EC-E822	19.1	12.7	5.6 - 8.7	4.8	0.020	1.9	10
EC-E825	22.2	19.1	6.3 - 6.3	4.8	0.050	3	10
EC-E823	25.4	15.9	5.6 - 8.7	4.8	0.050	3.4	10
EC-E824	31.8	25.4	8.0 - 12.7	7.1	0.113	4.8	2



Pocket Magnets

Part No	Length mm	Width mm	Height mm	Width of Gap	Weight (kg)	Max Pull (kg)	Pack Qty
EC-E802	28.5	7.6	25.4	6.3	0.030	2.4	10
EC-E803	33.3	15.9	35	7.9	0.090	4	5



Power Magnets

Part No	Length mm	Height mm	Width mm	Width of Gap mm	Hole Size mm	Hole Centres mm	Weight (kg)	Pull Force (kg)	Pack Qty
EC-811	30	20	20	15	5	N/A	0.060	4.5	5
EC-812	40	25	25	20	5	N/A	0.120	9	5
EC-813	45	30	30	23	5	N/A	0.180	11.8	2
EC-814	57	35	44.5	27.8	2 x 7.9	31.75	0.370	23.5	1
EC-815	70	41.3	57.2	34.1	2 x 7.9	38.10	0.710	37	1
EC-816	79.4	54	82.6	38.1	2 x 9.5	42.86	1.450	47	1
EC-817****	60.3	39.7	62	31.75	N/A	N/A	0.80	35	1
EC-818	79.4	54	85.7	47.6	N/A	N/A	1.80	60	1



**** Special Order Only

PERMANENT MAGNETS - POT MAGNETS

ALNICO
AlNiCo

Standard products indicated



Shallow Pot Magnets

Part No	Dia. mm	Height	Hole Size (Csk)	Screw Head Size	Weight Kg	Pull Force Kg	Pack Qty
EC-826	19	7.5	4.5	M3 Csk	0.010	3.0	10
EC-827	28.5	8.5	5.2	M4 Csk	0.030	5.0	10
EC-828	38.1	10.35	5.2	M4 Csk	0.080	13.0	5

Deep Pot Magnets

Part No	Dia. mm	Height	Thread Size	Weight Kg	Pull Force Kg	Pack Qty
EC-829	9.5	15	M3	0.005	1	10
EC-830	12.7	15.9	M4	0.015	2	10
EC-831	17.5	16	M6	0.023	2.65	10
EC-832	20.5	19	M6	0.040	4	5
EC-833	27	25	M6	0.085	6.1	5
EC-834	35	30	M6	0.184	14.75	2

Max. operating temperature 220°
Mild Steel pot
Painted Red



Max. operating temperature 220°
Mild Steel pot, aluminium spacer
Painted Red

Hook Magnets

Part No	Dia. mm	Pot Height mm	Total Height mm	Thread Size	Weight (kg)	Pull Force (kg)	Pack Qty
EC-E879-RB	25	8	34	M4	0.027	4.0	1
EC-E880-RB	32	8	34	M4	0.034	8.0	1
EC-E881-RB	36	8	34	M4	0.038	10.0	1
EC-M19863XR	32	7	38	M5	0.051	35	1

Shallow Pot Magnets

Part No	Dia. mm	Total Height mm	Thread Size	Weight (kg)	Pull Force (kg)	Pack Qty
EC-E890	46	10.7	M6	0.090	6	5
EC-E891	56	10.7	M6	0.130	16	5
EC-E892	66	10.7	M6	0.190	25	5

Max. operating temperature 120°
Mild steel pot with removeable hook
Painted red



Mild Steel pot. Painted white
***EC-19863XR Neodymium Magnet



Shallow Pot Magnets - M6 Tapped Holes

Part No	Dia. mm	Height mm	Fixing Stud Centres PCD M6	Centre Fixing Point	Weight (kg)	Pull Force (kg)	Pack Qty
EC-E895	66	10.7	46mm - 3 Holes	M6	0.270	25	1
EC-E896	76	12.5	46mm - 3 Holes	M6	0.300	33	1
EC-E897	100	15.5	70mm - 3 Holes	M6	0.610	55	1

Max. operating temperature 120°
Mild steel pot with removeable hook
Painted red
Three M6 tapped holes to aid mounting products



Please see our website for further details on all of our ranges



www.spearandjackson.com.au

A		C - Continued		G - Continued	
Air Blow Guns	103	Claw Hammer	52	Grommet Punch	58
Air Fittings General	108	Club Hammer	53	Grommets	58
Air Fittings Jamec Style	109	Coil Nailer	105	Groover - Cement	84, 99
Air Fittings Nitto Style	109	Cold Chisel	66, 121	Grout Remover	89
Air Fittings Ryco Style	108	Colours - Hand Cultivator	44	Grout Spreader	89
Air Hose	108	Colours - Hand Fork	44	Guarded Chisel	121
Air Hose - Recoil	108	Colours - Hand Trowel	44	Gutter Scoop	8
Air Hose Repair Kit	108	Colours - Loppers	44		
Air In Line Moisture Trap	107	Colours - Scoops	44, 45	H	
Air Kits & Accessories	106	Colours - Secateurs	44	Hatchet	41
Air Mini Filter Regulator	103	Colours - Shears	44	Hacksaw - Blades	116, 117
Air Nailers / Staplers	104, 105	Colours - Transplanter	44	Hacksaw - Junior	119
Air Tool & Compressor Oils	103	Colours - Weeder	44	Hacksaw - Mini	56, 118
Air Tyre Inflators	103	Colours Display Box Secateurs	45	Hacksaws	56, 118
Aluminium Pipe Wrench	138	Combination Set	145	Hammer - Ball Pein	53
Angle Bradder	105	Combination Square	145	Hammer - Brick	52, 73
Angle Brads	110	Compass Saw	82	Hammer - Claw	52
Archaeology Trowel	72	Concrete Chisel	66, 121	Hammer - Club	53
Aviation Snips	119	Concreting Float	83, 84, 94, 99	Hammer - Cross Pein	53
Axes	40	Contour Gauge	60, 90	Hammer - Dead Blow	55
		Coping Saw	56, 118, 119	Hammer - Replacement Tips	55
B		Coping Saw Blades	117	Hammer - Sledge	54
Ball Pein Hammer	53	Coving Tool External Corner	99	Hammer - Soft Face	55
Bar Magnet	147	Cross Pein Hammer	53	Hand Cultivator	8, 23
Bearing Scrapers	144	Crosscut Chisel	121	Hand Cultivator - Colours	44
Bevel	59	Cultivator - 3 Prong	7, 19	Hand Fork	8, 20, 23, 25, 27
Bevel - Premium	59	Cultivator - Hand	8, 23, 44	Hand Fork - Colours	44
Bevel - T Sliding	68	Cutter - Glass	89	Hand Soil Scoop	23
Blades - Coping Saw	117	Cutter - Scoring	89	Hand Tool - Gift Sets	20, 23
Blades - Fretsaw	117	Cutter - Tile	89	Hand Transplanter	8, 23, 25
Blades - General Purpose	117	Cutter - Tile Circular	89	Hand Transplanter - Colours	44
Blades - Hacksaw	116, 117	Cutter - Tile Mechanical	89	Hand Trowel	8, 20, 23, 25, 27
Blades - Junior	117			Hand Trowel - Colours	44
Blades - Piercing Saw	117	D		Hand Weeder	8, 23
Block Jointer	100	Dead Blow Hammer	55	Hand Weeder - Colours	44
Blocksplitters	41	Dutch Hoe	7, 19	Handle - Broom	42
Blow Guns	103	Dutch Pins	75	Handle - File	42
Board Lifter	81			Handle - Rake	42
Bolsters - Brick	66, 73	E		Hardwood Float	85
Bolsters - Brick Professional	66, 73	Edger - Cement	84, 99	Hawk - Plasterers	79, 94, 97
Bolsters - Electricians	73	Edging Knife	20	Hoe - Dutch	7, 19
Bolt Cutters - Forged, Tubular	120	Edging Shears	36	Hoe - Mortar	7, 87
Bow Saws	39	Engineers' Scrapers	144	Hoe - Swan Neck	7, 19
Bow Saws - Predator	38	Erector Scrapers	144	Hole Saw Set	56
Bradder - Angle	105	External Corner Coving Tool	99	Hook Magnet	148
Bradder - C, C1	104	External Corner Trowel	78, 98	Hopper Gun	87
Bradder / Stapler 2 in 1	104	Eyelets	58	Hose - Air	108
Brads - Angle	110			Hose Repair Kit - Air	108
Brads - C, C1	110	F		Hose Tidies	16
Brick Carrier	75	F Clamps	130		
Brick Hammer	52, 73	Fern Hook	37	I	
Brick Jointer	75, 100	File Handle	42	In Line Moisture Trap	107
Brick Trowel	71	Flat Chisel	121	Inflation Kits & Air Tool Starter Kits	103, 106
Brickline	74	Float - Concreting	83, 84, 94, 99	Internal Corner Trowel	78, 98
Broom Handle	42	Float - Finishing	83		
Bucket Trowel	79	Float - Grout	89	J	
Bulb Planter	8	Float - Hardwood	85	Jab Saw	82
Button Magnet	147	Float - Magnesium	85	Jamec Style Air Fittings	109
		Float - Notched	88, 94	Jeweller's Snips	119
C		Float - Pine	85	Joint Raker	75, 100
C Bradder	104	Float - Plasterers	78, 93, 95, 96, 97	Jointers - Block	100
C Brads	110	Float - Pointed Finishing	83, 84	Jointers - Brick	75, 100
C1 Bradder	104	Float - Polyurethane	80	Jointers - Sled	75
C1 Brads	110	Float - Rendering	81, 94	Jointing Knives	82
Cabinet Scrapers	100	Float - Sanding Poly	81	Junior Hacksaw	119
Camping Axe	41	Float - Sponge	80, 96		
Cane Knife	37	Float - Sponge Replacement	80, 96	K	
Carpenters Mallet	54	Floor Scrapers	91, 99	Kneeler Board	86
Carpenters Square	59	Floor Scrapers Blades	91, 99	Knife - Cane	37
Caulking Gun	90	Floorboard Chisel	121	Knife - Filling	67
C-Clamps - Locking	125	Forged Bolt Cutters	120	Knife - Hacking	57
Cement Edger	84, 99	Fork - Border	18, 22, 25	Knife - Jointing	82
Cement Groover	84, 99	Fork - Garden	5, 18, 22, 25, 27	Knife - Lino	57
Cement Sheet Cutter	85	Fork - Hand	8, 20, 23, 25, 27, 44	Knife - Putty	67, 91
Chalk Reel	60	Fork - Hay, Manure	6	Knife - Retractable	57
Chisel - Crosscut	121	Fork - Professional	13	Knife - Shoe	57
Chisel - Flat	121	Framing Nailer	105	Knife - Stripping	67
Chisel - Floorboard	121	Framing Nails	110	Knife - Taping	82
Chisel - Guarded	121	Fret Saw	118	Knife Edging	20
Chisels - Cold	66, 121				
Chisels - Concrete	66, 121	G		L	
Chisels - Plugging	66, 121	G Clamps	129	Lawn Shears	36
Chisels - Scutch	66	Gauge - Marking	68	Leaf Grabber	20
Clamps - F	130	Gauge - Mortice & Marking	68	Leather Punch	58
Clamps - G	129	Gauging Trowel	79	Leather Workwear	61, 62
Clamps - One Handed Bar	130	General Air Fittings	108	Level - Box	59
Clamps - Profile	75	General Purpose Saw	119	Level - Box Professional	59
Clamps - Sash	131	General Purpose Snips	119	Level - Bullseye	59
Clamps - Spring	57	Grass Shears	35	Level - Cross Check	59
Clamps - T-Bar	131	Gravity Feed Spray Guns & Kits	107	Level - Line	59

INDEX

L - Continued

Level - Torpedo	59
Line Block - Rubber	74
Line Pins	68, 75
Litter Picker	20
Locking C-Clamps	125
Locking Jaw Pliers	124
Loppers	32,33,44
Loppers - Anvil	33
Loppers - Bypass	32, 33, 44
Loppers - Colours	44
Loppers - Professional	32

M

Magnet - Bar	147
Magnet - Button	147
Magnet - Hook	148
Magnet - Minor	147
Magnet - Pocket	147
Magnet - Pot	148
Magnet - Power	147
Magnetic Adjustable Links	133
Magnetic Clamps "Quick"	132
Magnetic Clamps Heavy Duty	132
Magnetic Fixed Clamps	132
Magnetic Holder	133
Magnetic Holdfasts	132
Magnetic Lifters - Ultralift	135-136
Magnetic Mitre Clamps	133
Magnetic Positioner	133
Magnetic Variable Clamp	132
Magnetic Variable Clamp H/D	132
Magnets - D.I.Y	56
Mallet - Carpenters	54
Mallet - Rubber	54
Mallet - Rubber White	54
Margin Trowel	100
Marker - White Paint	56
Markers - Bullet Point	64
Markers - Chisel Point	64
Marking Gauge	68
Masonry Brush	73
Mattock - Cutter End	6, 9
Mattock - Pick End	6, 9
Measuring Tape	60
Mechanics Vice	127
Mini Filter Regulator	103
Minor Magnet	147
Mixing Paddle	81
Mortar Hoe	7, 87
Mortice & Marking Gauge	68
Moulders Trowel	100
Mulch / Grain Scoop	6

N

Nailer - Coil	105
Nailer - Framing	105
Nails - Framing	110
Narrow Crown Stapler	104
Narrow Crown Staples	110
Nitto Style Air Fittings	109
Notched Float	88, 94
Nut Spinners - BA/Metric	144
Nylon Workwear	63

O

Oils - Air Tool & Compressor	103
------------------------------	-----

P

Pencils - Carpenters	64
Pencils - Chinagraph	64
Piercing Saw	118
Pin Chuck	144
Pin Vices	144
Pine Float	85
Pincer - Post Hole	13
Pipe Wrench	68, 138
Pipe Wrench - Aluminium	138
Plasterers Float	78, 93, 95, 96, 97
Plasterers Hawk	79, 94, 97
Plasterers Square	82
Plier Punch	58
Pliers - Locking Jaw	124
Plugging Chisel	66, 121
Pocket Magnet	147
Pointer Tuck	100
Pointing Trowel	72
Pointing Finishing Float	83
Polyurethane Float	80
Post Hole Pincer	13
Pot Magnet	148

P - Continued

Power Magnet	147
Profile Clamp	75
Pruner - Tree Telescopic	39
Pruning Saw	39
Punch - Auto Centre	60, 144
Punch - Eyelets	58
Punch - Grommet	58
Punch - Leather	58
Punch - Plier	58

R

Rake - Fan	14, 15
Rake - Leaf / Plastic	14, 19
Rake - Nail / Garden	7, 19
Rake Handle	42
Rake - Landscapers	7
Raker - Joint	75, 100
Recoil Air Hose	108
Rendering Float	81, 94
Riveters	57, 141
Riveters Spares	141, 142
Rubber Mallet	54
Rubber Mallet - White	54
Rulers	60
Ryco Style Air Fittings	108

S

Sanding Float	81
Sash Clamps	131
Saw - Bow	38, 39
Saw - Brass Back Tenon	50
Saw - Compass	82
Saw - Coping	56, 118, 119
Saw - Fret	118
Saw - General Purpose	119
Saw - Hardpoint First Fix	49
Saw - Hardpoint Laminate	49
Saw - Hardpoint Predator X	49
Saw - Hardpoint Quick Cut	50
Saw - Hardpoint Tenon	50
Saw - Hardpoint Toolbox	50
Saw - Hardpoint Triplefast	49
Saw - Hardpoint Universal	49
Saw - Hardpoint UPVC	49
Saw - Jab	82
Saw - Mini Hacksaw	56, 118
Saw - Piercing	118
Saw - Professional Tenon	50
Saw - Pruning	39
Saw - Traditional Skew Back	50
Saw Tooth Setter	119
Scoop - Gutter	8
Scoop - Mulch / Grain	6
Scoops - Colours	44
Scraper Sets	67
Scrapers - Bearing	144
Scrapers - Cabinet	100
Scrapers - Engineers	144
Scrapers - Erectors	144
Scrapers - Flexible	91
Scrapers - Floor	91, 99
Scrapers - Floor Blades	91, 99
Scrapers - Stiff	91
Screeds	86
Scribers	145
Scutch Combs	66
Scythettes	37
Scythettes - Blade	37
Secateurs	30, 31, 32, 44, 45
Secateurs - Anvil	30, 31
Secateurs - Bypass	30, 31, 32, 44, 45
Secateurs - Colours	44
Secateurs - Colours Display Box	45
Secateurs - Professional	32
Secateurs - Sharpener	31
Sharpening Stone	57
Shears	34, 35, 44
Shears - Colours	44
Shears - Edging/Lawn	36
Shears - Grass	35
Shears - Telescopic	35
Shears - Topiary	35
Shears - Wishbone	34
Shovel - All Steel	13, 87
Shovel - General Purpose	12
Shovel - Plumbers	9, 10, 11, 12
Shovel - Post Hole	4, 9, 10, 11, 12
Shovel - Round Mouth	4, 5, 9, 10, 11
Shovel - Square Mouth	4, 5, 9, 10, 11
Shovel - Trenching	4, 9, 10, 11

S - Continued

Sled Jointer	75
Sledge Hammer	54
Small Tools	81
Snips - Aviation	119
Snips - General Purpose	119
Snips - Jeweller's	119
Socket Adaptor Set	56
Soft Face Hammer	55
Soil Scoop - Hand	23
Soil Spreader	7
Spacer - Cross Shape	91
Spacer - T-Shape	91
Spacer - Wedge Shape	91
Spade - Border	18, 22, 25
Spade - Cottage	5
Spade - Draining	13
Spade - Garden	5, 18, 22, 25, 27
Spade - Professional	13
Splash Trowel	100
Splatter Gun	94
Sponge Float	80, 96
Sponge Float Replacement	80, 96
Spray Guns	107
Sprayer - Pressure	16
Sprayer - Trigger	16
Spreader - Adhesive	88
Spreader - Grout	89
Spreader - Soil	7
Spring Clamps	57
Square - Carpenters	59, 68
Square - Combination	145
Square - Try & Mitre	59
Stapler - 80 Series	104
Stapler - Narrow Crown	104
Stapler / Bradder 2 in 1	104
Staples - 80 Series	110
Staples - Narrow Crown	110
Straight Edges	86
Stringline	74
Support Prop	81
Swan Neck Hoe	7, 19

T

Tap Wrench	145
Taping Knives	82
Tape Measure	60
T-Bar Clamps	131
Telescopic Tree Pruner	39
Threaded Insert Tool	142
Threaded Insert Tool Spares	142
Tile Borer, Nipper & Cutter	90
Tile Hole Cutter	90
Tiling Sponge	90
Topiary Shears	35
Trammel Heads	144
Transplanter - Hand	8, 23, 25
Trowel - Archaeology	72
Trowel - Brick	71
Trowel - Bucket	79
Trowel - External Corner	78, 98
Trowel - Gauging	79
Trowel - Hand	8, 20, 23, 25, 27, 44
Trowel - Internal Corner	78, 98
Trowel - Margin	100
Trowel - Moulders	100
Trowel - Pointing	72
Trowel - Splash	100
Trowel - Window	100
Tuck Pointer	100
Tyre Inflators	103

V

Vice - Accessories	128
Vice - Mechanics	127
Vice - Replacement Jaw Plates	127
Vice - Woodworking	128

W

Weeder - Hand	8, 23, 44
Window Trowel	100
Woodworking Vice	128
Workwear - Accessories	62
Workwear - Leather	61, 62
Workwear - Nylon	63
Wrecking Bars	58
Wrench Adjustable Soft Grip	139
Wrench Adjustable Steel	139
Wrench Adjustable Wide Jaw	139
Wrench - Pipe	138
Wrench - Tap	145

ECLIPSE

PROFESSIONAL TOOLS

CELEBRATING
OVER
100
YEARS
OF EXPERIENCE

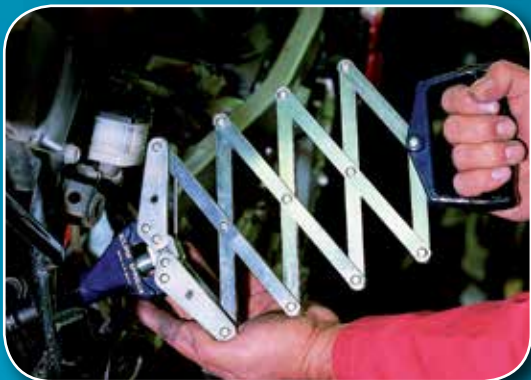

Eclipse Group – World Class Products for Worldwide Markets

Eclipse Group incorporates the world famous Eclipse Magnetics and Eclipse Professional Tools brands to form a portfolio of over 30,000 products. With over 100 years of experience Eclipse is a trusted supplier to some of the leading names in industry and commerce.

We are committed to supporting our customers through our worldwide sales support network. We also have distribution centres in Europe, Asia and North America.

CONTACT US:

Ph: 1300 731 818

Fax: 1300 735 858

Email: sales@spear-and-jackson.com.au

Web: www.spearandjackson.com.au

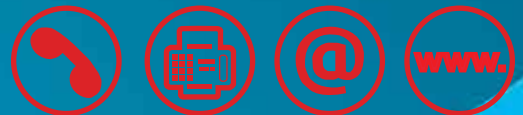

ECLIPSE CATALOGUE 2015

Due to continuous development and improvement, Spear & Jackson reserves the right to modify product design, specifications and materials without orior notice.



ECLIPSE

Group



Professional tools | Magnetic materials & assemblies | Magnetic technologies